

## LM4863 Boomer® Audio Power Amplifier Series

### Dual 2.2W Audio Amplifier Plus Stereo Headphone Function

#### General Description

The LM4863 is a dual bridge-connected audio power amplifier which, when connected to a 5V supply, will deliver 2.2W to a 4Ω load (Note 1) or 2.5W to a 3Ω load (Note 2) with less than 1.0% THD+N. In addition, the headphone input pin allows the amplifiers to operate in single-ended mode to drive stereo headphones.

Boomer audio power amplifiers were designed specifically to provide high quality output power from a surface mount package while requiring few external components. To simplify audio system design, the LM4863 combines dual bridge speaker amplifiers and stereo headphone amplifiers on one chip.

The LM4863 features an externally controlled, low-power consumption shutdown mode, a stereo headphone amplifier mode, and thermal shutdown protection. It also utilizes circuitry to reduce "clicks and pops" during device turn-on.

**Note 1:** An LM4863MTE which has been properly mounted to the circuit board will deliver 2.2W into 4Ω. The other package options for the LM4863 will deliver 1.1W into 8Ω. See the Application Information section for LM4863MTE usage information.

**Note 2:** An LM4863MTE which has been properly mounted to the circuit board and forced-air cooled will deliver 2.5W into 3Ω.

#### Key Specifications

■ P <sub>O</sub> at 1% THD+N	
into 3Ω (LM4863MTE)	2.5W(typ)
into 4Ω (LM4863MTE)	2.2W(typ)
into 8Ω (LM4863)	1.1W(typ)
■ Single-ended mode - THD+N	0.5%(max)
at 75mW into 32Ω	
■ Shutdown current	0.7μA(typ)

#### Features

- Stereo headphone amplifier mode
- "Click and pop" suppression circuitry
- Unity-gain stable
- Thermal shutdown protection circuitry
- Exposed-DAP TSSOP, TSSOP, SOIC and DIP packaging available

#### Applications

- Multimedia monitors
- Portable and desktop computers
- Portable televisions

#### Typical Application

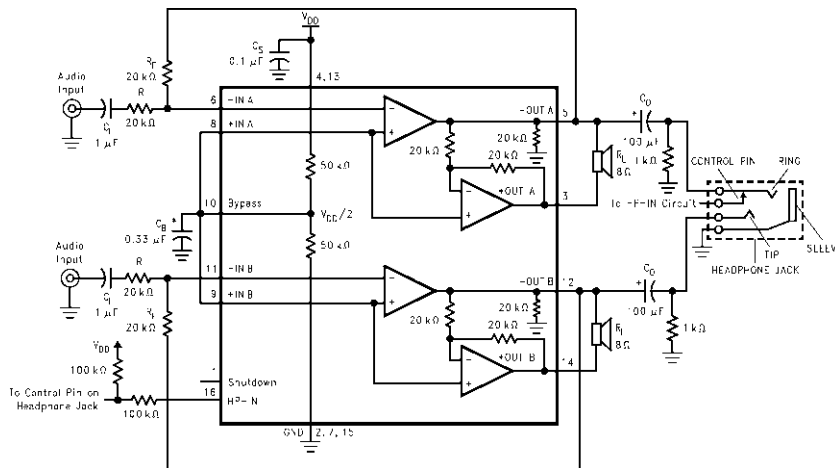

\* Refer to the section Proper Selection of External Components, for a detailed discussion of C<sub>B</sub> size.

**FIGURE 1. Typical Audio Amplifier Application Circuit**

Boomer® is a registered trademark of National Semiconductor Corporation.

## Connection Diagrams

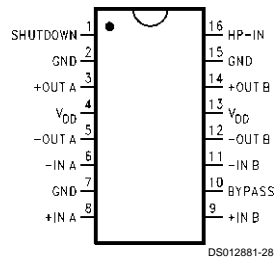

**Top View**  
**Order Number LM4863M, LM4863N**  
**See NS Package Number M16B for SO**  
**See NS Package Number N16A for DIP**

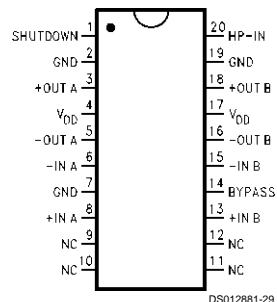

**Top View**  
**Order Number LM4863MT**  
**See NS Package Number MTC20 for TSSOP**

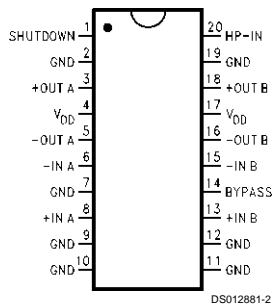

**Top View**  
**Order Number LM4863MTE**  
**See NS Package Number MXA20A for Exposed-DAP TSSOP**

**Absolute Maximum Ratings** (Note 4)

If Military/Aerospace specified devices are required, please contact the National Semiconductor Sales Office/ Distributors for availability and specifications.

Supply Voltage	6.0V
Storage Temperature	-65°C to +150°C
Input Voltage	-0.3V to $V_{DD} + 0.3V$
Power Dissipation (Note 10)	Internally limited
ESD Susceptibility (Note 11)	2000V
ESD Susceptibility (Note 12)	200V
Junction Temperature	150°C
Solder Information	
Small Outline Package	
Vapor Phase (60 sec.)	215°C
Infrared (15 sec.)	220°C
See AN-450 "Surface Mounting and their Effects on Product Reliability" for other methods of soldering surface mount devices.	

## Thermal Resistance

$\theta_{JC}$ (typ) — M16B	20°C/W
$\theta_{JA}$ (typ) — M16B	80°C/W
$\theta_{JC}$ (typ) — N16A	20°C/W
$\theta_{JA}$ (typ) — N16A	63°C/W
$\theta_{JC}$ (typ) — MTC20	20°C/W
$\theta_{JA}$ (typ) — MTC20	80°C/W
$\theta_{JC}$ (typ) — MXA20A	2°C/W
$\theta_{JA}$ (typ) — MXA20A	41°C/W (Note 7)
$\theta_{JA}$ (typ) — MXA20A	51°C/W (Note 5)
$\theta_{JA}$ (typ) — MXA20A	90°C/W (Note 6)

**Operating Ratings**

## Temperature Range

$$T_{MIN} \leq T_A \leq T_{MAX} \quad -40^\circ\text{C} \leq T_A \leq 85^\circ\text{C}$$

## Supply Voltage

$$2.0V \leq V_{DD} \leq 5.5V$$

**Electrical Characteristics for Entire IC** (Notes 3, 4)

The following specifications apply for  $V_{DD} = 5V$  unless otherwise noted. Limits apply for  $T_A = 25^\circ\text{C}$ .

Symbol	Parameter	Conditions	LM4863		Units (Limits)
			Typical (Note 13)	Limit (Note 14)	
$V_{DD}$	Supply Voltage			2	V (min)
				5.5	V (max)
$I_{DD}$	Quiescent Power Supply Current	$V_{IN} = 0V, I_O = 0A$ (Note 15), HP-IN = 0V	11.5	20	mA (max)
		$V_{IN} = 0V, I_O = 0A$ (Note 15), HP-IN = 4V	5.8	6	mA (min) mA
$I_{SD}$	Shutdown Current	$V_{PIN1} = V_{DD}$	0.7	2	$\mu\text{A}$ (min)
$V_{IH}$	Headphone High Input Voltage			4	V (min)
$V_{IL}$	Headphone Low Input Voltage			0.8	V (max)

**Electrical Characteristics for Bridged-Mode Operation** (Notes 3, 4)

The following specifications apply for  $V_{DD} = 5V$  unless otherwise specified. Limits apply for  $T_A = 25^\circ\text{C}$ .

Symbol	Parameter	Conditions	LM4863		Units (Limits)
			Typical (Note 13)	Limit (Note 14)	
$V_{OS}$	Output Offset Voltage	$V_{IN} = 0V$	5	50	mV (max)
$P_O$	Output Power (Note 9)	THD = 1%, $f = 1\text{ kHz}$ LM4863MTE, $R_L = 3\Omega$ (Note 7)	2.5		W
		LM4863MTE, $R_L = 4\Omega$ (Note 8)	2.2		W
		LM4863, $R_L = 8\Omega$	1.1	1.0	W (min)
		THD+N = 10%, $f = 1\text{ kHz}$ LM4863MTE, $R_L = 3\Omega$ (Note 7)	3.2		W
		LM4863MTE, $R_L = 4\Omega$ (Note 8)	2.7		W
		LM4863, $R_L = 8\Omega$	1.5		W
THD+N	Total Harmonic Distortion+Noise	THD+N = 1%, $f = 1\text{ kHz}, R_L = 32\Omega$	0.34		W
		20 Hz $\leq f \leq 20\text{ kHz}$ , $A_{VD} = 2$ LM4863MTE, $R_L = 4\Omega$ , $P_O = 2W$ LM4863, $R_L = 8\Omega$ , $P_O = 1W$	0.3		%
PSRR	Power Supply Rejection Ratio	$V_{DD} = 5V, V_{RIPPLE} = 200\text{ mV}_{RMS}, R_L = 8\Omega, C_B = 1.0\text{ }\mu\text{F}$	67		dB

### Electrical Characteristics for Bridged-Mode Operation (Notes 3, 4) (Continued)

The following specifications apply for  $V_{DD} = 5V$  unless otherwise specified. Limits apply for  $T_A = 25^\circ C$ .

Symbol	Parameter	Conditions	LM4863		Units (Limits)
			Typical (Note 13)	Limit (Note 14)	
$X_{TALK}$	Channel Separation	$f = 1 \text{ kHz}, C_B = 1.0 \mu F$	90		dB
SNR	Signal To Noise Ratio	$V_{DD} = 5V, P_O = 1.1W, R_L = 8\Omega$	98		dB

### Electrical Characteristics for Single-Ended Operation (Notes 3, 4)

The following specifications apply for  $V_{DD} = 5V$  unless otherwise specified. Limits apply for  $T_A = 25^\circ C$ .

Symbol	Parameter	Conditions	LM4863		Units (Limits)
			Typical (Note 13)	Limit (Note 14)	
$V_{OS}$	Output Offset Voltage	$V_{IN} = 0V$	5	50	mV (max)
$P_O$	Output Power	THD = 0.5%, $f = 1 \text{ kHz}, R_L = 32\Omega$ THD+N = 1%, $f = 1 \text{ kHz}, R_L = 8\Omega$ THD+N = 10%, $f = 1 \text{ kHz}, R_L = 8\Omega$	85 340 440	75	mW (min) mW mW
THD+N	Total Harmonic Distortion+Noise	$A_V = -1, P_O = 75 \text{ mW}, 20 \text{ Hz} \leq f \leq 20 \text{ kHz}, R_L = 32\Omega$	0.2		%
PSRR	Power Supply Rejection Ratio	$C_B = 1.0 \mu F, V_{RIPPLE} = 200 \text{ mV}_{RMS}, f = 1 \text{ kHz}$	52		dB
$X_{TALK}$	Channel Separation	$f = 1 \text{ kHz}, C_B = 1.0 \mu F$	60		dB
SNR	Signal To Noise Ratio	$V_{DD} = 5V, P_O = 340mW, R_L = 8\Omega$	95		dB

**Note 3:** All voltages are measured with respect to the ground pins, 2, 7, and 15, unless otherwise specified.

**Note 4:** Absolute Maximum Ratings indicate limits beyond which damage to the device may occur. Operating Ratings indicate conditions for which the device is functional, but do not guarantee specific performance limits. Electrical Characteristics state DC and AC electrical specifications under particular test conditions which guarantee specific performance limits. This assumes that the device is within the Operating Ratings. Specifications are not guaranteed for parameters where no limit is given, however, the typical value is a good indication of device performance.

**Note 5:** The  $\theta_{JA}$  given is for an MXA20A package whose exposed-DAP is soldered to an exposed  $2in^2$  piece of 1 ounce printed circuit board copper.

**Note 6:** The  $\theta_{JA}$  given is for an MXA20A package whose exposed-DAP is not soldered to any copper.

**Note 7:** When driving  $3\Omega$  loads from a 5V supply, the LM4863MTE must be mounted to the circuit board and forced-air cooled (450 linear-feet per minute).

**Note 8:** When driving  $4\Omega$  loads from a 5V supply, the LM4863MTE must be mounted to the circuit board.

**Note 9:** Output power is measured at the device terminals.

**Note 10:** The maximum power dissipation must be derated at elevated temperatures and is dictated by  $T_{JMAX}, \theta_{JA}$ , and the ambient temperature  $T_A$ . The maximum allowable power dissipation is  $P_{DMAX} = (T_{JMAX} - T_A)/\theta_{JA}$ . For the LM4863,  $T_{JMAX} = 150^\circ C$ . For the  $\theta_{JA}$ s for different packages, please see the Application Information section or the Absolute Maximum Ratings section.

**Note 11:** Human body model, 100 pF discharged through a 1.5 k $\Omega$  resistor.

**Note 12:** Machine model, 220 pF–240 pF discharged through all pins.

**Note 13:** Typicals are measured at  $25^\circ C$  and represent the parametric norm.

**Note 14:** Limits are guaranteed to National's AOQL (Average Outgoing Quality Level).

**Note 15:** The quiescent power supply current depends on the offset voltage when a practical load is connected to the amplifier.

### Truth Table for Logic Inputs

SHUTDOWN	HP-IN	LM4863 MODE
Low	Low	Bridged
Low	High	Single-Ended
High	Low	LM4863 Shutdown
High	High	LM4863 Shutdown

## External Components Description

(Figure 1)

Components	Functional Description
1. $R_i$	Inverting input resistance which sets the closed-loop gain in conjunction with $R_f$ . This resistor also forms a high pass filter with $C_i$ at $f_c = 1/(2\pi R_i C_i)$ .
2. $C_i$	Input coupling capacitor which blocks the DC voltage at the amplifier's input terminals. Also creates a highpass filter with $R_i$ at $f_c = 1/(2\pi R_i C_i)$ . Refer to the section, <b>Proper Selection of External Components</b> , for an explanation of how to determine the value of $C_i$ .
3. $R_f$	Feedback resistance which sets the closed-loop gain in conjunction with $R_i$ .
4. $C_s$	Supply bypass capacitor which provides power supply filtering. Refer to the <b>Power Supply Bypassing</b> section for information concerning proper placement and selection of the supply bypass capacitor.
5. $C_B$	Bypass pin capacitor which provides half-supply filtering. Refer to the section, <b>Proper Selection of External Components</b> , for information concerning proper placement and selection of $C_B$ .

## Typical Performance Characteristics MTE Specific Characteristics

LM4863MTE  
THD+N vs Output Power

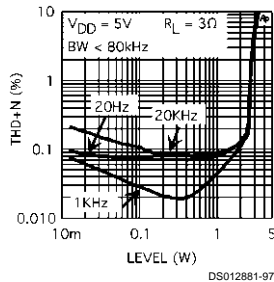

LM4863MTE  
THD+N vs Frequency

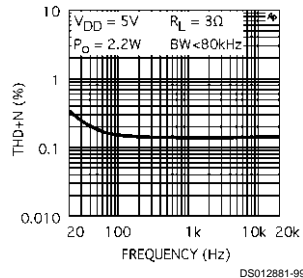

LM4863MTE  
THD+N vs Output Power

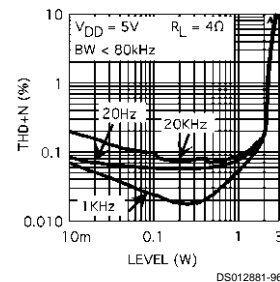

LM4863MTE  
THD+N vs Frequency

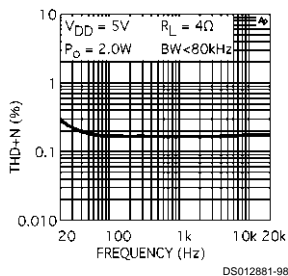

LM4863MTE  
Power Dissipation vs Power Output

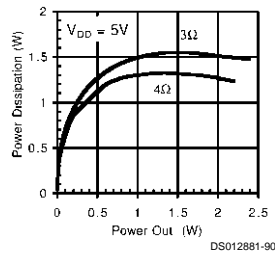

LM4863MTE (Note 16)  
Power Derating Curve

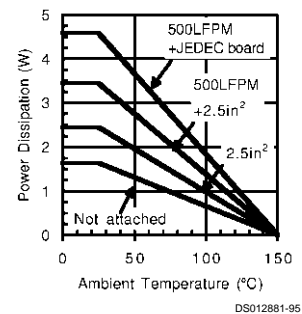

**Note 16:** These curves show the thermal dissipation ability of the LM4863MTE at different ambient temperatures given these conditions:

**500LFPM + JEDEC board:** The part is soldered to a 1S2P 20-lead exposed-DAP TSSOP test board with 500 linear feet per minute of forced-air flow across it. **Board information** - copper dimensions: 74x74mm, copper coverage: 100% (buried layer) and 12% (top/bottom layers), 16 vias under the exposed-DAP.

**500LFPM + 2.5in<sup>2</sup>:** The part is soldered to a 2.5in<sup>2</sup>, 1 oz. copper plane with 500 linear feet per minute of forced-air flow across it.

**2.5in<sup>2</sup>:** The part is soldered to a 2.5in<sup>2</sup>, 1oz. copper plane.

**Not Attached:** The part is not soldered down and is not forced-air cooled.

## Non-MTE Specific Characteristics

THD+N vs Frequency

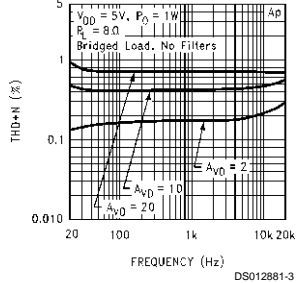

THD+N vs Frequency

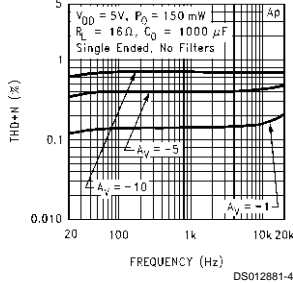

THD+N vs Frequency

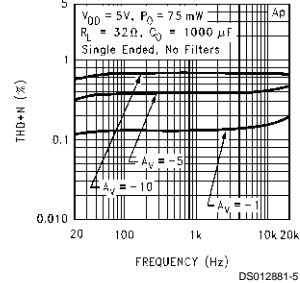

THD+N vs Output Power

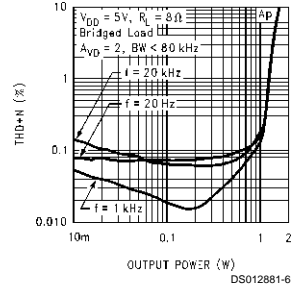

THD+N vs Output Power

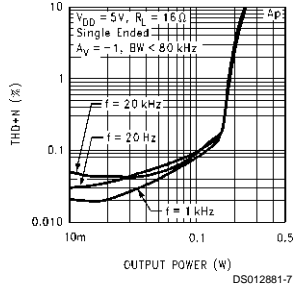

THD+N vs Output Power

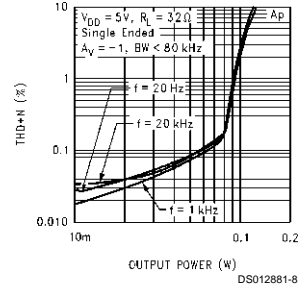

THD+N vs Output Power

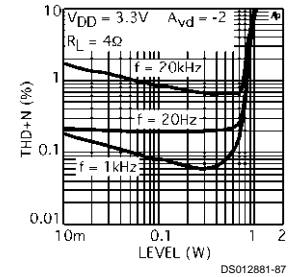

THD+N vs Frequency

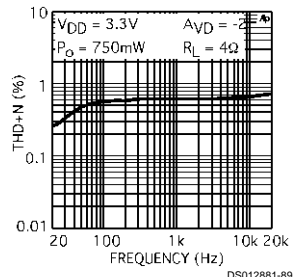

THD+N vs Output Power

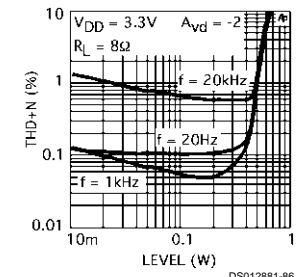

THD+N vs Frequency

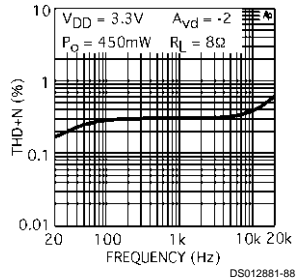

Output Power vs Load Resistance

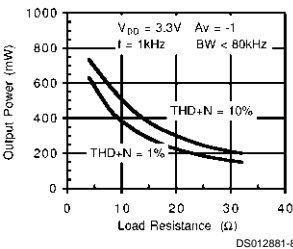

Power Dissipation vs Supply Voltage

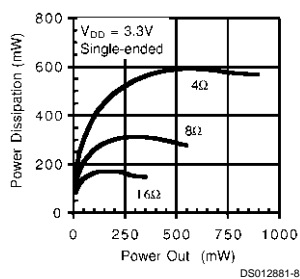

### Non-MTE Specific Characteristics (Continued)

**Output Power vs Supply Voltage**

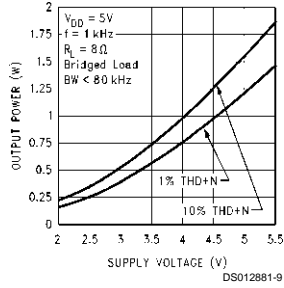

**Output Power vs Supply Voltage**

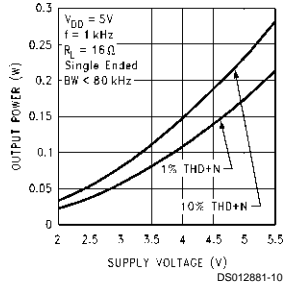

**Output Power vs Supply Voltage**

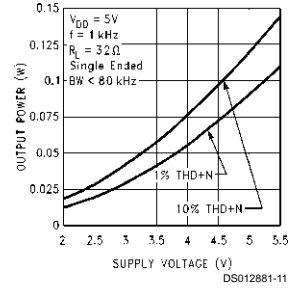

**Output Power vs Load Resistance**

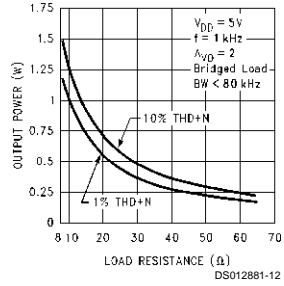

**Output Power vs Load Impedance**

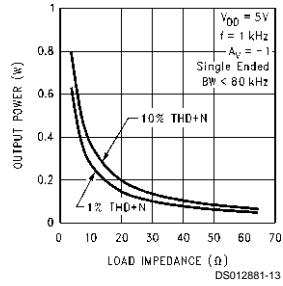

**Power Dissipation vs Output Power**

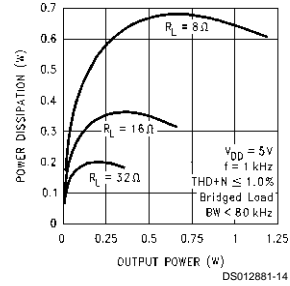

**Dropout Voltage vs Supply Voltage**

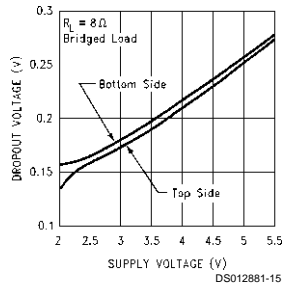

**Power Derating Curve**

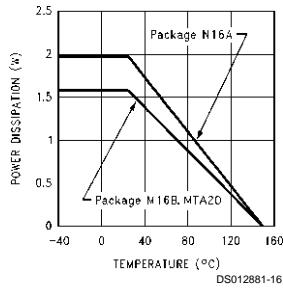

**Power Dissipation vs Output Power**

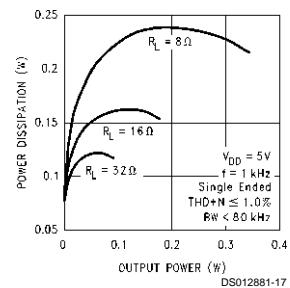

**Noise Floor**

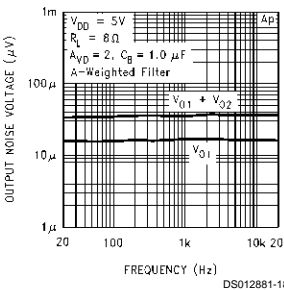

**Channel Separation**

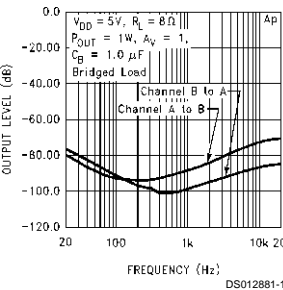

**Channel Separation**

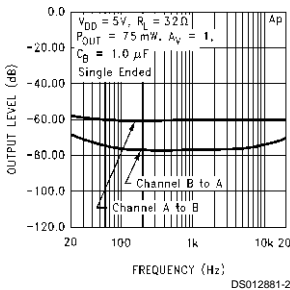

## Non-MTE Specific Characteristics (Continued)

**Power Supply Rejection Ratio**

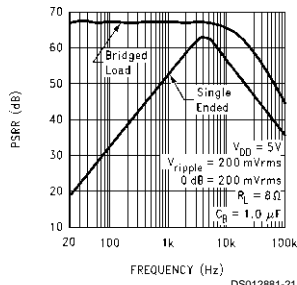

**Open Loop Frequency Response**

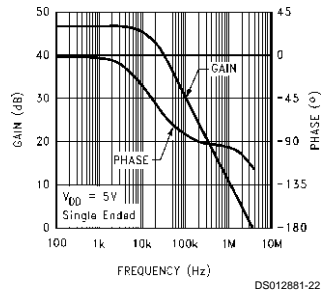

**Supply Current vs Supply Voltage**

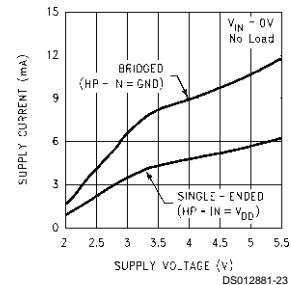

## Application Information

### EXPOSED-DAP MOUNTING CONSIDERATIONS

The exposed-DAP must be connected to ground. The exposed-DAP package of the LM4863MTE requires special attention to thermal design. If thermal design issues are not properly addressed, an LM4863MTE driving 4Ω will go into thermal shutdown.

The exposed-DAP on the bottom of the LM4863MTE should be soldered down to a copper pad on the circuit board. Heat is conducted away from the exposed-DAP by a copper plane. If the copper plane is not on the top surface of the circuit board, 8 to 10 vias of 0.013 inches or smaller in diameter should be used to thermally couple the exposed-DAP to the plane. For good thermal conduction, the vias must be plated-through and solder-filled.

The copper plane used to conduct heat away from the exposed-DAP should be as large as practical. If the plane is on the same side of the circuit board as the exposed-DAP, 2.5in<sup>2</sup> is the minimum for 5V operation into 4Ω. If the heat sink plane is buried or not on the same side as the exposed-DAP, 5in<sup>2</sup> is the minimum for 5V operation into 4Ω. If the ambient temperature is higher than 25°C, a larger copper plane or forced-air cooling will be required to keep the LM4863MTE junction temperature below the thermal shutdown temperature (150°C). See the power derating curve for the LM4863MTE for derating information.

The LM4863MTE requires forced-air cooling when operating into 3Ω. With the part attached to 2.5in<sup>2</sup> of exposed copper, with a 3Ω load, and with an ambient temperature of 25°C, 450 linear-feet per minute kept the part out of thermal shutdown. In higher ambient temperatures, higher airflow rates and/or larger copper areas will be required to keep the part out of thermal shutdown.

See **DEMOBOARD CIRCUIT LAYOUT** for an example of an exposed-DAP TSSOP circuit board layout.

### 3Ω & 4Ω LAYOUT CONSIDERATIONS

With low impedance loads, the output power at the loads is heavily dependent on trace resistance from the output pins of the LM4863. Traces from the output of the LM4863MTE to the load or load connectors should be as wide as practical. Any resistance in the output traces will reduce the power delivered to the load. For example, with a 4Ω load and 0.1Ω of trace resistance in each output, output power at the load drops from 2.2W to 2.0W

Output power is also dependent on supply regulation. To keep the supply voltage from sagging under full output power conditions, the supply traces should be as wide as practical.

### BRIDGE CONFIGURATION EXPLANATION

As shown in *Figure 1*, the LM4863 has two pairs of operational amplifiers internally, allowing for a few different amplifier configurations. The first amplifier's gain is externally configurable, while the second amplifier is internally fixed in a unity-gain, inverting configuration. The closed-loop gain of the first amplifier is set by selecting the ratio of  $R_f$  to  $R_i$  while the second amplifier's gain is fixed by the two internal 20 kΩ resistors. *Figure 1* shows that the output of amplifier one serves as the input to amplifier two which results in both amplifiers producing signals identical in magnitude, but out of phase 180°. Consequently, the differential gain for each channel of the IC is

$$A_{VD} = 2 * (R_f/R_i)$$

By driving the load differentially through outputs +OutA and -OutA or +OutB and -OutB, an amplifier configuration commonly referred to as "bridged mode" is established. Bridged mode operation is different from the classical single-ended amplifier configuration where one side of its load is connected to ground.

A bridge amplifier design has a few distinct advantages over the single-ended configuration, as it provides differential drive to the load, thus doubling the output swing for a specified supply voltage. Four times the output power is possible as compared to a single-ended amplifier under the same conditions. This increase in attainable output power assumes that the amplifier is not current limited or clipped. In order to choose an amplifier's closed-loop gain without causing excessive clipping, please refer to the **Audio Power Amplifier Design** section.

A bridge configuration, such as the one used in LM4863, also creates a second advantage over single-ended amplifiers. Since the differential outputs, +OutA, -OutA, +OutB, and -OutB, are biased at half-supply, no net DC voltage exists across the load. This eliminates the need for an output coupling capacitor which is required in a single supply, single-ended amplifier configuration. If an output coupling capacitor is not used in a single-ended configuration, the half-supply bias across the load would result in both increased internal IC power dissipation as well as permanent loudspeaker damage.

## Application Information (Continued)

### POWER DISSIPATION

Whether the power amplifier is bridged or single-ended, power dissipation is a major concern when designing the amplifier. Equation 1 states the maximum power dissipation point for a single-ended amplifier operating at a given supply voltage and driving a specified load.

$$P_{\text{DMAX}} = (V_{\text{DD}})^2 / (2\pi^2 R_L): \text{ Single-Ended} \quad (1)$$

However, a direct consequence of the increased power delivered to the load by a bridge amplifier is an increase in internal power dissipation. Equation 2 states the maximum power dissipation point for a bridge amplifier operating at the same given conditions.

$$P_{\text{DMAX}} = 4 * (V_{\text{DD}})^2 / (2\pi^2 R_L): \text{ Bridge Mode} \quad (2)$$

Since the LM4863 is a dual channel power amplifier, the maximum internal power dissipation is 2 times that of Equation 1 or Equation 2 depending on the mode of operation. Even with this substantial increase in power dissipation, the LM4863 does not require heatsinking. The power dissipation from Equation 2, assuming a 5V power supply and an 8Ω load, must not be greater than the power dissipation that results from Equation 3:

$$P_{\text{DMAX}} = (T_{\text{JMAX}} - T_{\text{A}}) / \theta_{\text{JA}} \quad (3)$$

For packages M16A and MTA20,  $\theta_{\text{JA}} = 80^\circ\text{C/W}$ , and for package N16A,  $\theta_{\text{JA}} = 63^\circ\text{C/W}$ .  $T_{\text{JMAX}} = 150^\circ\text{C}$  for the LM4863. Depending on the ambient temperature,  $T_{\text{A}}$ , of the system surroundings, Equation 3 can be used to find the maximum internal power dissipation supported by the IC packaging. If the result of Equation 2 is greater than that of Equation 3, then either the supply voltage must be decreased, the load impedance increased, or the ambient temperature reduced. For the typical application of a 5V power supply, with an 8Ω bridged load, the maximum ambient temperature possible without violating the maximum junction temperature is approximately 48°C provided that device operation is around the maximum power dissipation point and assuming surface mount packaging. Internal power dissipation is a function of output power. If typical operation is not around the maximum power dissipation point, the ambient temperature can be increased. Refer to the **Typical Performance Characteristics** curves for power dissipation information for different output powers.

### POWER SUPPLY BYPASSING

As with any power amplifier, proper supply bypassing is critical for low noise performance and high power supply rejection. The capacitor location on both the bypass and power supply pins should be as close to the device as possible. The effect of a larger half supply bypass capacitor is improved PSRR due to increased half-supply stability. Typical applications employ a 5V regulator with 10 μF and a 0.1 μF bypass capacitors which aid in supply filtering. This does not eliminate the need for bypassing the supply nodes of the LM4863. The selection of bypass capacitors, especially  $C_{\text{B}}$ , is thus dependent upon desired PSRR requirements, click and pop performance as explained in the section, **Proper Selection of External Components**, system cost, and size constraints.

### SHUTDOWN FUNCTION

In order to reduce power consumption while not in use, the LM4863 contains a shutdown pin to externally turn off the amplifier's bias circuitry. This shutdown feature turns the amplifier off when a logic high is placed on the shutdown pin.

The trigger point between a logic low and logic high level is typically half supply. It is best to switch between ground and the supply  $V_{\text{DD}}$  to provide maximum device performance. By switching the shutdown pin to  $V_{\text{DD}}$ , the LM4863 supply current draw will be minimized in idle mode. While the device will be disabled with shutdown pin voltages less than  $V_{\text{DD}}$ , the idle current may be greater than the typical value of 0.7 μA. In either case, the shutdown pin should be tied to a definite voltage to avoid unwanted state changes.

In many applications, a microcontroller or microprocessor output is used to control the shutdown circuitry which provides a quick, smooth transition into shutdown. Another solution is to use a single-pole, single-throw switch in conjunction with an external pull-up resistor. When the switch is closed, the shutdown pin is connected to ground and enables the amplifier. If the switch is open, then the external pull-up resistor will disable the LM4863. This scheme guarantees that the shutdown pin will not float, thus preventing unwanted state changes.

### HP-IN FUNCTION

The LM4863 possesses a headphone control pin that turns off the amplifiers which drive +OutA and +OutB so that single-ended operation can occur and a bridged connected load is muted. Quiescent current consumption is reduced when the IC is in this single-ended mode.

*Figure 2* shows the implementation of the LM4863's headphone control function using a single-supply headphone amplifier. The voltage divider of R1 and R2 sets the voltage at the HP-IN pin (pin 16) to be approximately 50 mV when there are no headphones plugged into the system. This logic-low voltage at the HP-IN pin enables the LM4863 and places it in bridged mode operation. Resistor R4 limits the amount of current flowing out of the HP-IN pin when the voltage at that pin goes below ground resulting from the music coming from the headphone amplifier. The output coupling capacitors protect the headphones by blocking the amplifier's half supply DC voltage.

When there are no headphones plugged into the system and the IC is in bridged mode configuration, both loads are essentially at a 0V DC potential. Since the HP-IN threshold is set at 4V, even in an ideal situation, the output swing cannot cause a false single-ended trigger.

When a set of headphones are plugged into the system, the contact pin of the headphone jack is disconnected from the signal pin, interrupting the voltage divider set up by resistors R1 and R2. Resistor R1 then pulls up the HP-IN pin, enabling the headphone function. This disables the second side of the amplifier thus muting the bridged speakers. The amplifier then drives the headphones, whose impedance is in parallel with resistors R2 and R3. Resistors R2 and R3 have negligible effect on output drive capability since the typical impedance of headphones are 32Ω. Also shown in *Figure 2* are the electrical connections for the headphone jack and plug. A 3-wire plug consists of a Tip, Ring and Sleeve, where the Tip and Ring are signal carrying conductors and the Sleeve is the common ground return. One control pin contact for each headphone jack is sufficient to indicate to control inputs that the user has inserted a plug into a jack and that another mode of operation is desired.

The LM4863 can be used to drive both a pair of bridged 8Ω speakers and a pair of 32Ω headphones without using the HP-IN pin. In this case the HP-IN would not be connected to the headphone jack but to a microprocessor or a switch. By enabling the HP-IN pin, the 8Ω speakers can be muted.

## Application Information (Continued)

### PROPER SELECTION OF EXTERNAL COMPONENTS

Proper selection of external components in applications using integrated power amplifiers is critical to optimize device and system performance. While the LM4863 is tolerant to a

variety of external component combinations, consideration to component values must be used to maximize overall system quality.

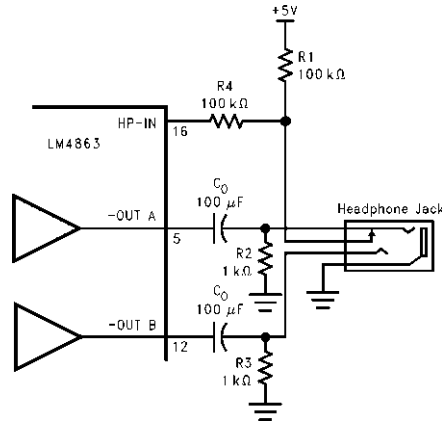

DS012881-24

FIGURE 2. Headphone Circuit

The LM4863 is unity-gain stable, giving the designer maximum system performance. The LM4863 should be used in low gain configurations to minimize THD+N values, and maximize the signal to noise ratio. Low gain configurations require large input signals to obtain a given output power. Input signals equal to or greater than  $1 V_{rms}$  are available from sources such as audio codecs. Please refer to the section, **Audio Power Amplifier Design**, for a more complete explanation of proper gain selection.

Besides gain, one of the major considerations is the closed-loop bandwidth of the amplifier. To a large extent, the bandwidth is dictated by the choice of external components shown in *Figure 1*. The input coupling capacitor,  $C_i$ , forms a first order high pass filter which limits low frequency response. This value should be chosen based on needed frequency response for a few distinct reasons.

#### CLICK AND POP CIRCUITRY

The LM4863 contains circuitry to minimize turn-on transients or "clicks and pops". In this case, turn-on refers to either power supply turn-on or the device coming out of shutdown mode. When the device is turning on, the amplifiers are internally configured as unity gain buffers. An internal current source ramps up the voltage of the bypass pin. Both the inputs and outputs ideally track the voltage at the bypass pin. The device will remain in buffer mode until the bypass pin has reached its half supply voltage,  $1/2 V_{DD}$ . As soon as the bypass node is stable, the device will become fully operational, where the gain is set by the external resistors.

Although the bypass pin current source cannot be modified, the size of  $C_B$  can be changed to alter the device turn-on time and the amount of "clicks and pops". By increasing amount of turn-on pop can be reduced. However, the tradeoff for using a larger bypass capacitor is an increase in turn-on time for this device. There is a linear relationship between the size of  $C_B$  and the turn-on time. Here are some typical turn-on times for a given  $C_B$ :

$C_B$	$T_{ON}$
0.01 $\mu F$	20 ms
0.1 $\mu F$	200 ms
0.22 $\mu F$	420 ms
0.47 $\mu F$	840 ms
1.0 $\mu F$	2 Sec

In order eliminate "clicks and pops", all capacitors must be discharged before turn-on. Rapid on/off switching of the device or the shutdown function may cause the "click and pop" circuitry to not operate fully, resulting in increased "click and pop" noise. In a single-ended configuration, the output coupling capacitor,  $C_O$ , is of particular concern. This capacitor discharges through the internal 20 k $\Omega$  resistors. Depending on the size of  $C_O$ , the time constant can be relatively large. To reduce transients in single-ended mode, an external 1 k $\Omega$ –5 k $\Omega$  resistor can be placed in parallel with the internal 20 k $\Omega$  resistor. The tradeoff for using this resistor is an increase in quiescent current.

The value of  $C_i$  will also reflect turn-on pops. Clearly, a certain size for  $C_i$  is needed to couple in low frequencies without excessive attenuation. But in many cases, the speakers used in portable systems, whether integral or external, have little ability to reproduce signals below 100 Hz to 150 Hz. In this case, using a large input and output capacitor may not increase system performance. In most cases, choosing a small value of  $C_i$  in the range of 0.1  $\mu F$  to 0.33  $\mu F$ , along with  $C_B$  equal to 1.0  $\mu F$  should produce a virtually clickless and popless turn-on. In cases where  $C_i$  is larger than 0.33  $\mu F$ , it may be advantageous to increase the value of  $C_B$ . Again, it should be understood that increasing the value of  $C_B$  will reduce the "clicks and pops" at the expense of a longer device turn-on time.

## Application Information (Continued)

### NO-LOAD DESIGN CONSIDERATIONS

If the outputs of the LM4863 have a load higher than 10kΩ, the LM4863 may show a small oscillation at high output levels. To prevent this oscillation, place 5kΩ resistors from the power outputs to ground.

### AUDIO POWER AMPLIFIER DESIGN

#### Design a 1W/8Ω Bridged Audio Amplifier

Given:

Power Output:	1 Wrms
Load Impedance:	8Ω
Input Level:	1 Wrms
Input Impedance:	20 kΩ

Bandwidth: 100 Hz–20 kHz ± 0.25 dB

A designer must first determine the minimum supply rail to obtain the specified output power. By extrapolating from the Output Power vs Supply Voltage graphs in the **Typical Performance Characteristics** section, the supply rail can be easily found. A second way to determine the minimum supply rail is to calculate the required  $V_{\text{peak}}$  using Equation 3 and add the dropout voltage. Using this method, the minimum supply voltage would be  $(V_{\text{peak}} + (2 * V_{\text{od}}))$ , where  $V_{\text{od}}$  is extrapolated from the Dropout Voltage vs Supply Voltage curve in the **Typical Performance Characteristics** section.

$$V_{\text{peak}} = \sqrt{(2R_L P_O)} \quad (4)$$

Using the Output Power vs Supply Voltage graph for an 8Ω load, the minimum supply rail is 3.9V. But since 5V is a standard supply voltage in most applications, it is chosen for the supply rail. Extra supply voltage creates headroom that allows the LM4863 to reproduce peaks in excess of 1W without producing audible distortion. At this time, the designer must make sure that the power supply choice along with the output impedance does not violate the conditions explained in the **Power Dissipation** section.

Once the power dissipation equations have been addressed, the required differential gain can be determined from Equation 4.

$$A_{VD} \geq \sqrt{(P_O R_L)} / (V_{IN}) = V_{\text{orms}} / V_{\text{inrms}} \quad (5)$$

$$R_f / R_i = A_{VD} / 2 \quad (6)$$

From equation 4, the minimum  $A_{VD}$  is 2.83; use  $A_{VD} = 3$ . Since the desired input impedance was 20 kΩ, and with a  $A_{VD}$  of 3, a ratio of 1.5:1 of  $R_f$  to  $R_i$  results in an allocation of  $R_i = 20$  kΩ and  $R_f = 30$  kΩ. The final design step is to address the bandwidth requirements which must be stated as a pair of –3 dB frequency points. Five times away from a pole gives 0.17 dB down from passband response, which is better than the required ±0.25 dB specified.

$$f_L = 100 \text{ Hz} / 5 = 20 \text{ Hz}$$

$$f_H = 20 \text{ kHz} \times 5 = 100 \text{ kHz}$$

As stated in the **External Components** section,  $R_i$  in conjunction with  $C_i$  create a highpass filter.

$$C_i \geq \frac{1}{2\pi R_i f_c}$$

$$C_i \geq 1 / (2\pi * 20 \text{ k}\Omega * 20 \text{ Hz}) = 0.397 \mu\text{F}; \text{ use } 0.33 \mu\text{F}$$

The high frequency pole is determined by the product of the desired high frequency pole,  $f_H$ , and the differential gain,  $A_{VD}$ . With a  $A_{VD} = 3$  and  $f_H = 100$  kHz, the resulting GBWP = 150 kHz which is much smaller than the LM4863 GBWP of 3.5 MHz. This figure displays that if a designer has a need to design an amplifier with a higher differential gain, the LM4863 can still be used without running into bandwidth problems.

### DEMOBOARD CIRCUIT LAYOUT

The demoboard circuit layout is provided here as an example of a circuit using the LM4863. If an LM4863MTE is used with this layout, the exposed-DAP is soldered down to the copper pad beneath the part. Heat is conducted away from the part by the two large copper pads in the upper corners of the demoboard.

This demoboard provides enough heat dissipation ability to allow an LM4863MTE to output 2.2W into 4Ω at 25°C.

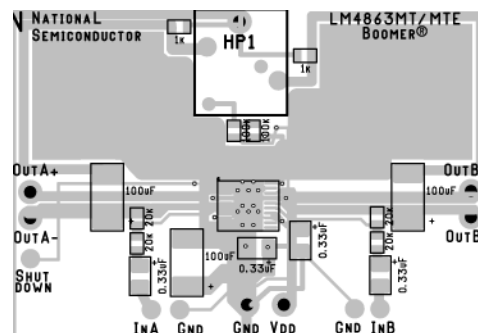

All Layers

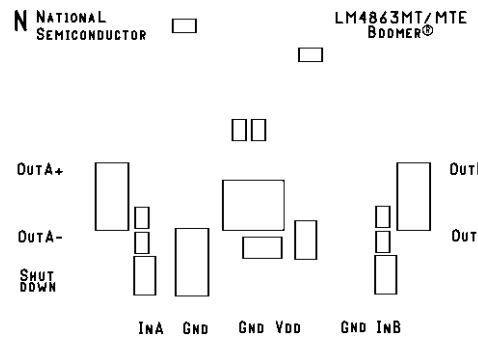

Silk Screen Layer

### Application Information (Continued)

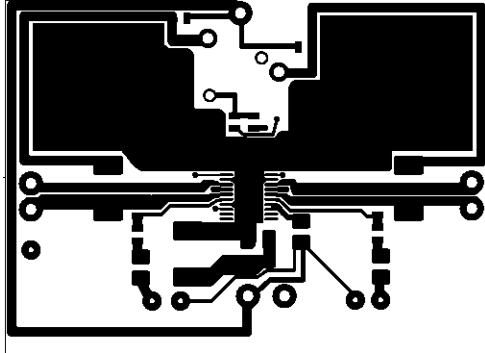

DS012881-91

Component-side Copper Layers

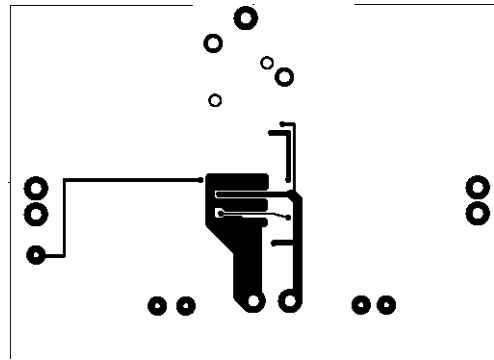

DS012881-92

Solder-side Copper Layers

**Physical Dimensions** inches (millimeters) unless otherwise noted

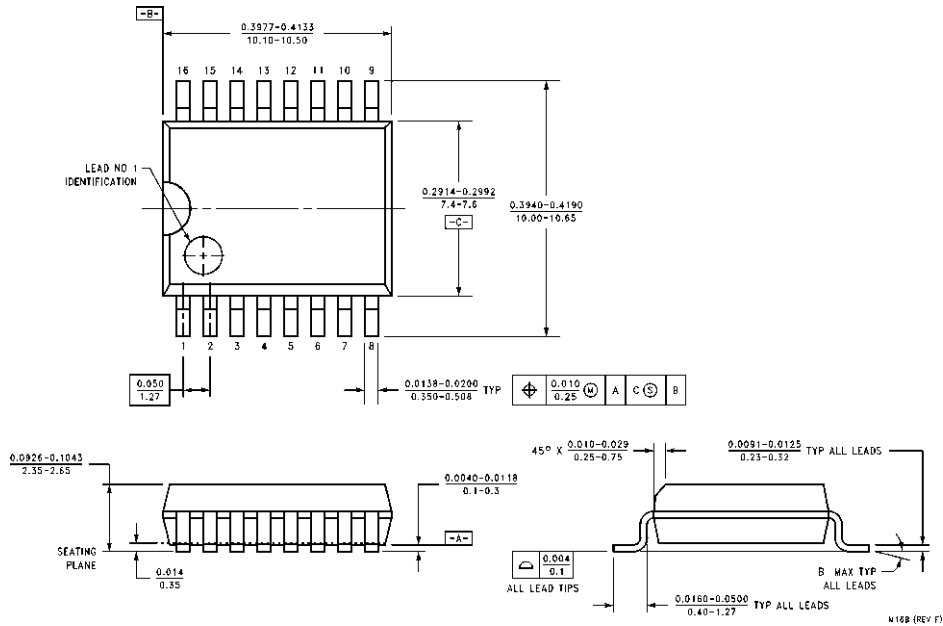

**16-Lead (0.300" Wide) Molded Small Outline Package, JEDEC**  
**Order Number LM4863M**  
**NS Package Number M16B**

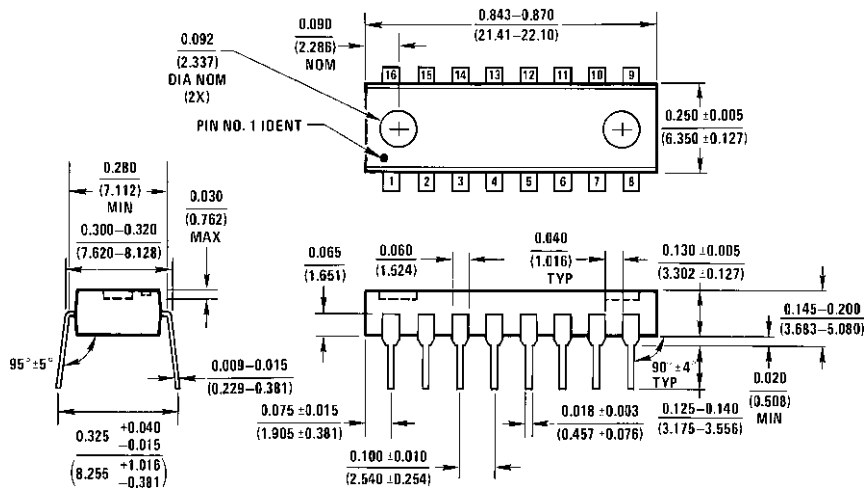

**16-Lead (0.300" Wide) Molded Dual-In-Line Package**  
**Order Number LM4863N**  
**NS Package Number N16A**

**Physical Dimensions** inches (millimeters) unless otherwise noted (Continued)

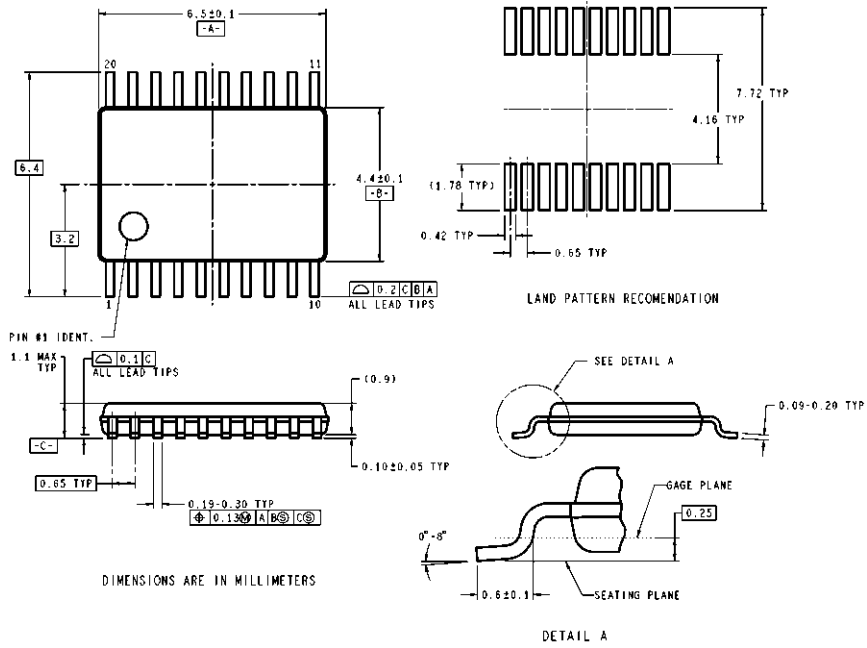

**20-Lead Molded PKG, TSSOP, JEDEC, 4.4mm BODY WIDTH**  
**Order Number LM4863MT**  
**NS Package Number MTC20**

MTC20 (Rev D)

**Physical Dimensions** inches (millimeters) unless otherwise noted (Continued)

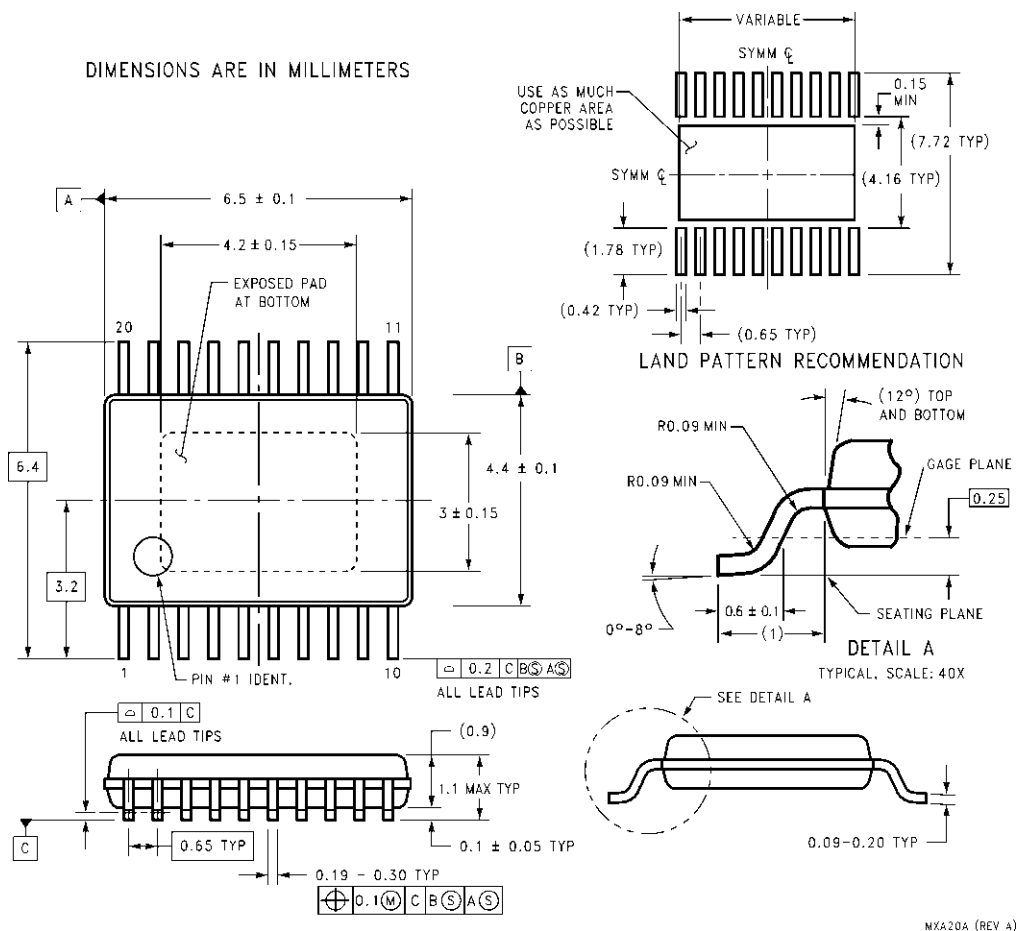

**20-Lead Molded TSSOP, Exposed Pad, 6.5x4.4x0.9mm**  
**Order Number LM4863MTE**  
**NS Package Number MXA20A**

MXA20A (REV A)

## Notes

### LIFE SUPPORT POLICY

NATIONAL'S PRODUCTS ARE NOT AUTHORIZED FOR USE AS CRITICAL COMPONENTS IN LIFE SUPPORT DEVICES OR SYSTEMS WITHOUT THE EXPRESS WRITTEN APPROVAL OF THE PRESIDENT AND GENERAL COUNSEL OF NATIONAL SEMICONDUCTOR CORPORATION. As used herein:

1. Life support devices or systems are devices or systems which, (a) are intended for surgical implant into the body, or (b) support or sustain life, and whose failure to perform when properly used in accordance with instructions for use provided in the labeling, can be reasonably expected to result in a significant injury to the user.
2. A critical component is any component of a life support device or system whose failure to perform can be reasonably expected to cause the failure of the life support device or system, or to affect its safety or effectiveness.



**National Semiconductor Corporation**  
Americas  
Tel: 1-800-272-9959  
Fax: 1-800-737-7018  
Email: support@nsc.com

www.national.com

**National Semiconductor Europe**

Fax: +49 (0) 1 80-530 85 86  
Email: europe.support@nsc.com  
Deutsch Tel: +49 (0) 1 80-530 85 85  
English Tel: +49 (0) 1 80-532 78 32  
Français Tel: +49 (0) 1 80-532 93 58  
Italiano Tel: +49 (0) 1 80-534 16 80

**National Semiconductor Asia Pacific Customer Response Group**

Tel: 65-2544466  
Fax: 65-2504466  
Email: sea.support@nsc.com

**National Semiconductor Japan Ltd.**

Tel: 81-3-5639-7560  
Fax: 81-3-5639-7507