

TOSHIBA Bipolar Digital Integrated Circuit Silicon Monolithic

ULN2803APG,ULN2803AFWG,ULN2804APG,ULN2804AFWG

8ch Darlington Sink Driver

The ULN2803APG / AFWG Series are high-voltage, high-current darlington drivers comprised of eight NPN darlington pairs. All units feature integral clamp diodes for switching inductive loads. Applications include relay, hammer, lamp and display (LED) drivers.

Features

- Output current (single output)
500 mA (max)
- High sustaining voltage output
50 V (min)
- Output clamp diodes
- Inputs compatible with various types of logic.
- Package Type-APG : DIP-18pin
- Package Type-AFWG : SOL-18pin

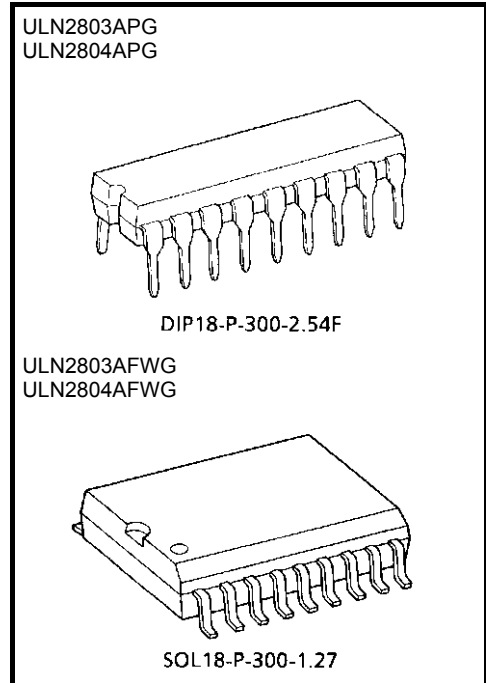

Weight
 DIP18-P-300-2.54F: 1.478 g (Typ.)
 SOL18-P-300-1.27 : 0.48 g (Typ.)

Type	Input Base Resistor	Designation
ULN2803APG / AFWG	2.7 kΩ	TTL, 5 V CMOS
ULN2804APG / AFWG	10.5 kΩ	6~15 V PMOS, CMOS

Pin Connection (top view)

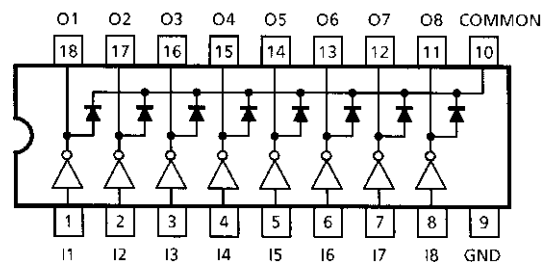

Schematics (each driver)

ULN2803APG / AFWG

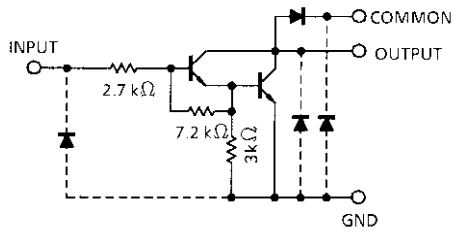

ULN2804APG / AFWG

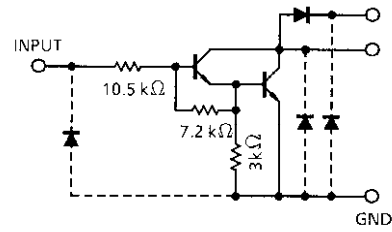

Note: The input and output parasitic diodes cannot be used as clamp diodes.

Absolute Maximum Ratings (Ta = 25°C)

Characteristic	Symbol	Rating	Unit
Output sustaining voltage	$V_{CE(SUS)}$	-0.5 to 50	V
Output current	I_{OUT}	500	mA / ch
Input voltage	V_{IN}	-0.5 to 30	V
Clamp diode reverse voltage	V_R	50	V
Clamp diode forward current	I_F	500	mA
Power dissipation	APG	P_D	W
	AFWG		
		0.92 / 1.31 (Note)	
Operating temperature	T_{opr}	-40 to 85	°C
Storage temperature	T_{stg}	-55 to 150	°C

Note: On Glass Epoxy PCB (75 × 114 × 1.6 mm Cu 20%)

Recommended Operating Conditions (Ta = -40~85°C)

Characteristic		Symbol	Test Condition	Min	Typ.	Max	Unit
Output sustaining voltage		V _{CE (SUS)}		0	—	50	V
Output current	APG	I _{OUT}	t _{pw} = 25 ms, Duty = 10%, 8 Circuits	0	—	347	mA / ch
			t _{pw} = 25 ms, Duty = 50%, 8 Circuits	0	—	123	
	AFWG		t _{pw} = 25 ms, Duty = 10%, 8 Circuits	0	—	268	
			t _{pw} = 25 ms, Duty = 50%, 8 Circuits	0	—	90	
Input voltage		V _{IN}		0	—	30	V
Input voltage (Output on)	ULN2803A	V _{IN (ON)}		2.5	—	30	V
	ULN2804A			8	—	30	
Clamp diode reverse voltage		V _R		—	—	50	V
Clamp diode forward current		I _F		—	—	400	mA
Power dissipation	APG	P _D	Ta = 85°C	—	—	0.76	W
	AFWG		Ta = 85°C (Note)	—	—	0.48	

Note: On Glass Epoxy PCB (75 × 114 × 1.6 mm Cu 20%)

Electrical Characteristics (Ta = 25°C)

Characteristic		Symbol	Test Cir-Cuit	Test Condition	Min	Typ.	Max	Unit
Output leakage current	ULN2804A	I _{CEX}	1	V _{CE} = 50 V, Ta = 25°C	—	—	50	μA
				V _{CE} = 50 V, Ta = 85°C	—	—	100	
				V _{CE} = 50 V, V _{IN} = 1 V	—	—	500	
Collector-emitter saturation voltage		V _{CE (sat)}	2	I _{OUT} = 350 mA, I _{IN} = 500 μA	—	1.3	1.6	V
				I _{OUT} = 200 mA, I _{IN} = 350 μA	—	1.1	1.3	
				I _{OUT} = 100 mA, I _{IN} = 250 μA	—	0.9	1.1	
Input current	ULN2803A	I _{IN (ON)}	2	V _{IN} = 3.85 V	—	0.93	1.35	mA
	ULN2804A			V _{IN} = 5 V	—	0.35	0.5	
				V _{IN} = 12 V	—	1.0	1.45	
		I _{IN (OFF)}	4	I _{OUT} = 500 μA, Ta = 85°C	50	65	—	μA
Input voltage (Output on)	ULN2803A	V _{IN (ON)}	5	V _{CE} = 2 V, I _{OUT} = 200 mA	—	—	2.4	V
				V _{CE} = 2 V, I _{OUT} = 250 mA	—	—	2.7	
				V _{CE} = 2 V, I _{OUT} = 300 mA	—	—	3.0	
	ULN2804A			V _{CE} = 2 V, I _{OUT} = 125 mA	—	—	5.0	
				V _{CE} = 2 V, I _{OUT} = 200 mA	—	—	6.0	
				V _{CE} = 2 V, I _{OUT} = 275 mA	—	—	7.0	
				V _{CE} = 2 V, I _{OUT} = 350 mA	—	—	8.0	
DC current transfer ratio		h _{FE}	2	V _{CE} = 2 V, I _{OUT} = 350 mA	1000	—	—	
Clamp diode reverse current		I _R	6	Ta = 25°C (Note)	—	—	50	μA
				Ta = 85°C (Note)	—	—	100	
Clamp diode forward voltage		V _F	7	I _F = 350 mA	—	—	2.0	V
Input capacitance		C _{IN}	—		—	15	—	pF
Turn-on delay		t _{ON}	8	R _L = 125 Ω, V _{OUT} = 50 V	—	0.1	—	μs
Turn-off delay		t _{OFF}		R _L = 125 Ω, V _{OUT} = 50 V	—	0.2	—	

Note: V_R = V_R (max)

Test Circuit

1. I_{CEX}

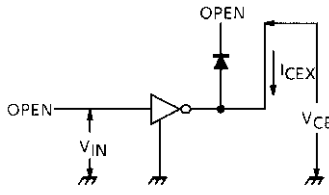

2. $V_{CE} (sat)$, h_{FE}

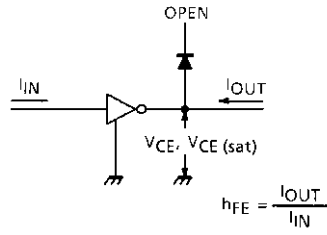

3. $I_{IN} (ON)$

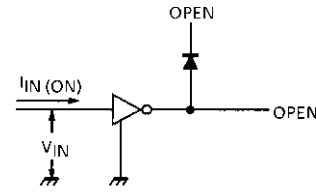

4. $I_{IN} (OFF)$

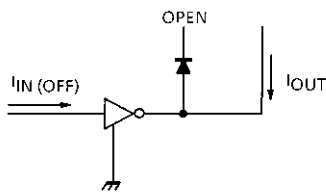

5. $V_{IN} (ON)$

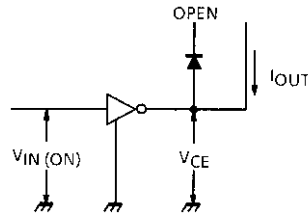

6. I_R

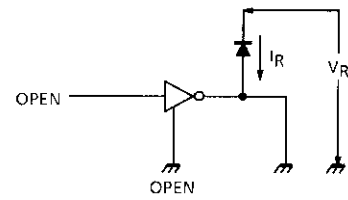

7. V_F

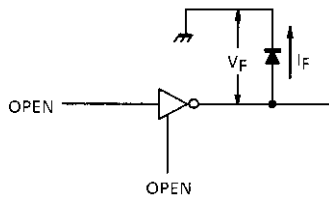

8. t_{ON}, t_{OFF}

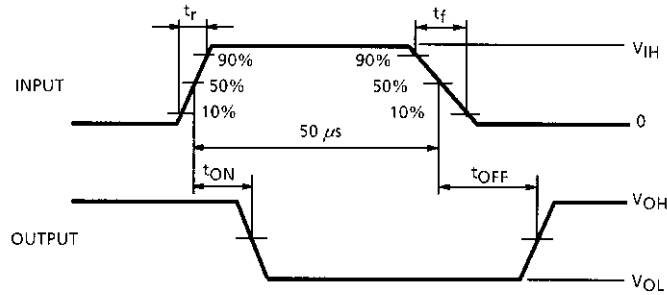
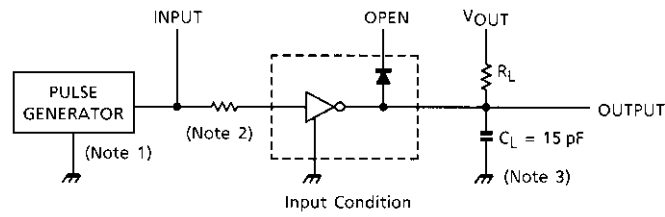

Note 1: Pulse Width 50 μs, Duty Cycle 10%
Output Impedance 50 Ω, t_r ≤ 5 ns, t_f ≤ 10 ns

Note 2: See below.

Input Condition

Type Number	R1	V _{IH}
ULN2803A	0Ω	3 V
ULN2804A	0Ω	8 V

Note 3: C_L includes probe and jig capacitance

Precautions for Using

This IC does not integrate protection circuits such as overcurrent and overvoltage protectors.

Thus, if excess current or voltage is applied to the IC, the IC may be damaged. Please design the IC so that excess current or voltage will not be applied to the IC.

Utmost care is necessary in the design of the output line, COMMON and GND line since IC may be destroyed due to short-circuit between outputs, air contamination fault, or fault by improper grounding.

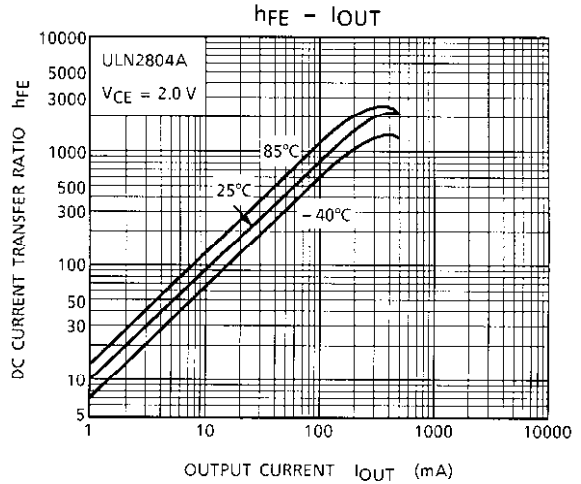
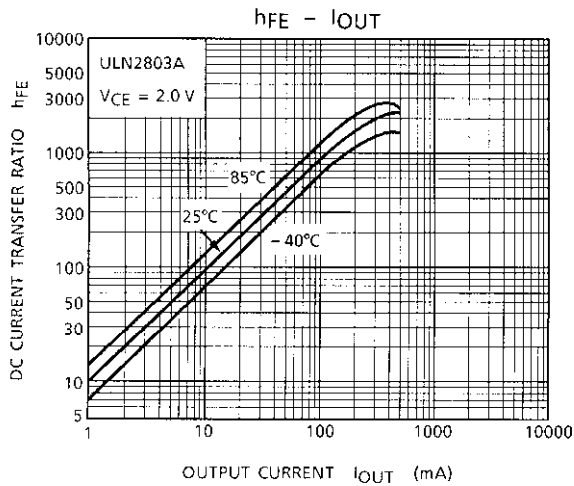
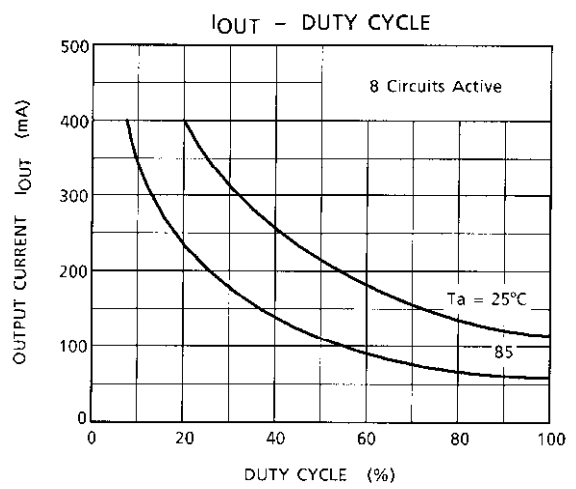
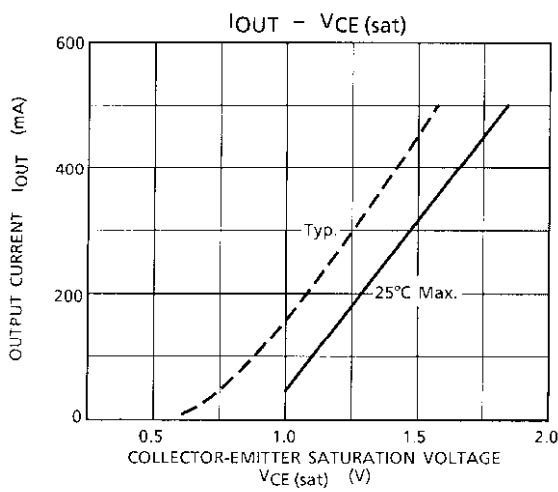
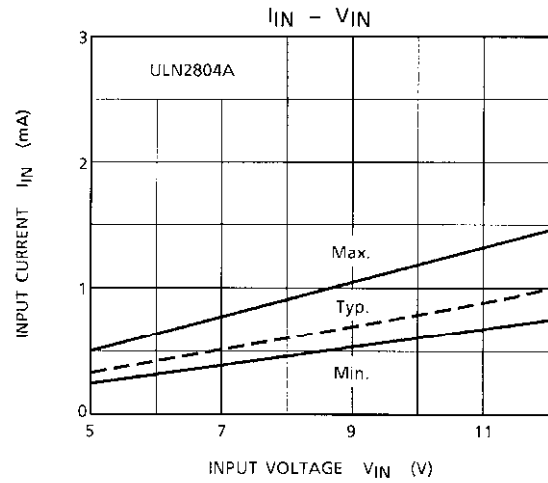
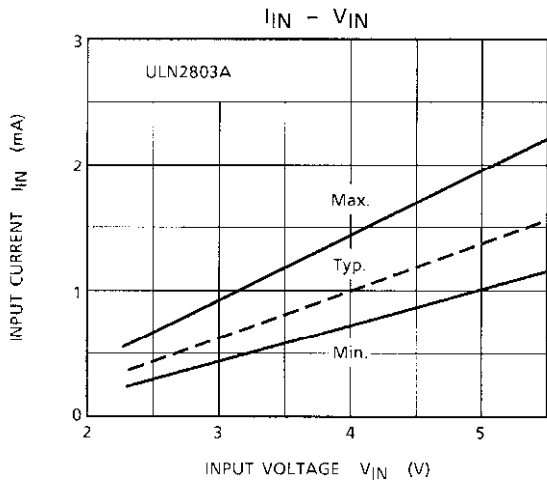

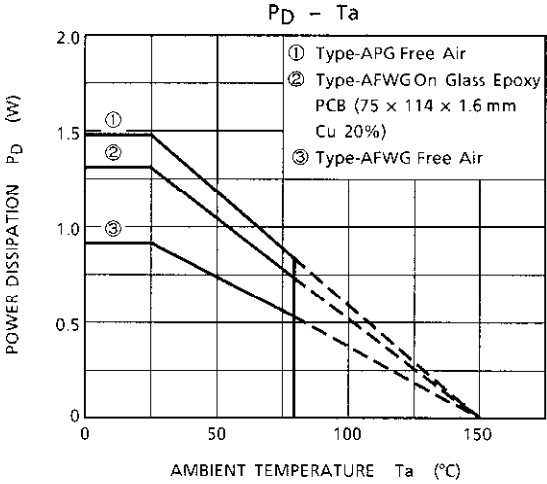

Package Dimensions

DIP18-P-300-2.54F

Unit: mm

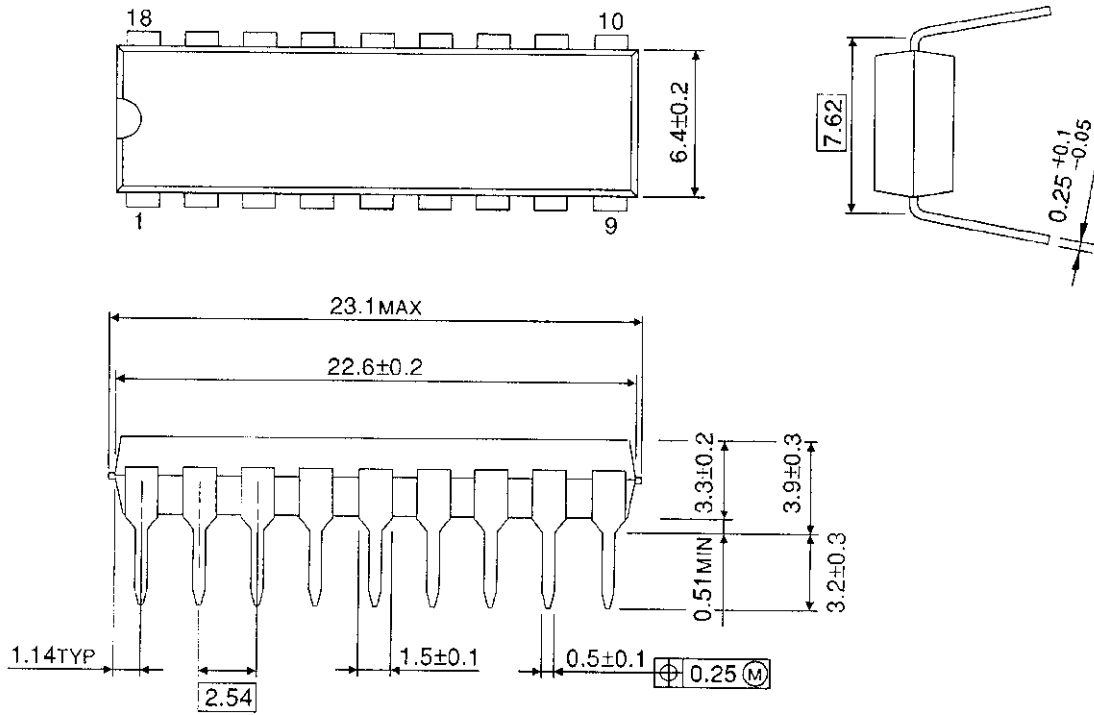

Weight: 1.478 g (Typ.)

Package Dimensions

SOL18-P-300-1.27

Unit: mm

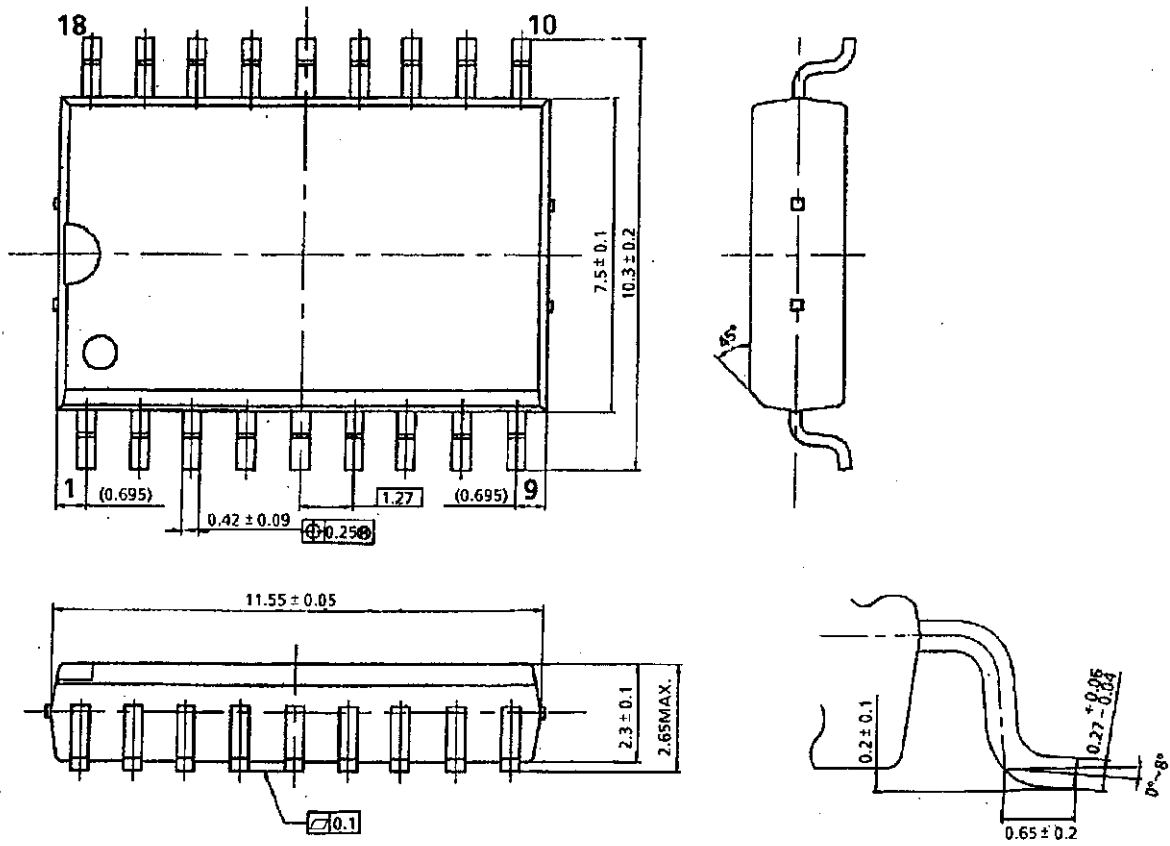

Weight: 0.48 g (Typ.)

Notes on Contents

1. Equivalent Circuits

The equivalent circuit diagrams may be simplified or some parts of them may be omitted for explanatory purposes.

2. Test Circuits

Components in the test circuits are used only to obtain and confirm the device characteristics. These components and circuits are not guaranteed to prevent malfunction or failure from occurring in the application equipment.

IC Usage Considerations

Notes on Handling of ICs

- (1) The absolute maximum ratings of a semiconductor device are a set of ratings that must not be exceeded, even for a moment. Do not exceed any of these ratings.
Exceeding the rating(s) may cause the device breakdown, damage or deterioration, and may result injury by explosion or combustion.
- (2) Use an appropriate power supply fuse to ensure that a large current does not continuously flow in case of over current and/or IC failure. The IC will fully break down when used under conditions that exceed its absolute maximum ratings, when the wiring is routed improperly or when an abnormal pulse noise occurs from the wiring or load, causing a large current to continuously flow and the breakdown can lead smoke or ignition. To minimize the effects of the flow of a large current in case of breakdown, appropriate settings, such as fuse capacity, fusing time and insertion circuit location, are required.
- (3) If your design includes an inductive load such as a motor coil, incorporate a protection circuit into the design to prevent device malfunction or breakdown caused by the current resulting from the inrush current at power ON or the negative current resulting from the back electromotive force at power OFF. IC breakdown may cause injury, smoke or ignition.
Use a stable power supply with ICs with built-in protection functions. If the power supply is unstable, the protection function may not operate, causing IC breakdown. IC breakdown may cause injury, smoke or ignition.
- (4) Do not insert devices in the wrong orientation or incorrectly.
Make sure that the positive and negative terminals of power supplies are connected properly. Otherwise, the current or power consumption may exceed the absolute maximum rating, and exceeding the rating(s) may cause the device breakdown, damage or deterioration, and may result injury by explosion or combustion.
In addition, do not use any device that is applied the current with inserting in the wrong orientation or incorrectly even just one time.
- (5) Carefully select external components (such as inputs and negative feedback capacitors) and load components (such as speakers), for example, power amp and regulator.
If there is a large amount of leakage current such as input or negative feedback condenser, the IC output DC voltage will increase. If this output voltage is connected to a speaker with low input withstand voltage, overcurrent or IC failure can cause smoke or ignition. (The over current can cause smoke or ignition from the IC itself.) In particular, please pay attention when using a Bridge Tied Load (BTL) connection type IC that inputs output DC voltage to a speaker directly.

Points to Remember on Handling of ICs

(1) Heat Radiation Design

In using an IC with large current flow such as power amp, regulator or driver, please design the device so that heat is appropriately radiated, not to exceed the specified junction temperature (T_j) at any time and condition. These ICs generate heat even during normal use. An inadequate IC heat radiation design can lead to decrease in IC life, deterioration of IC characteristics or IC breakdown. In addition, please design the device taking into consideration the effect of IC heat radiation with peripheral components.

(2) Back-EMF

When a motor rotates in the reverse direction, stops or slows down abruptly, a current flow back to the motor's power supply due to the effect of back-EMF. If the current sink capability of the power supply is small, the device's motor power supply and output pins might be exposed to conditions beyond absolute maximum ratings. To avoid this problem, take the effect of back-EMF into consideration in system design.

About solderability, following conditions were confirmed

• Solderability

(1) Use of Sn-37Pb solder Bath

- solder bath temperature = 230°C
- dipping time = 5 seconds
- the number of times = once
- use of R-type flux

(2) Use of Sn-3.0Ag-0.5Cu solder Bath

- solder bath temperature = 245°C
- dipping time = 5 seconds
- the number of times = once
- use of R-type flux

RESTRICTIONS ON PRODUCT USE

- Toshiba Corporation, and its subsidiaries and affiliates (collectively "TOSHIBA"), reserve the right to make changes to the information in this document, and related hardware, software and systems (collectively "Product") without notice.
- This document and any information herein may not be reproduced without prior written permission from TOSHIBA. Even with TOSHIBA's written permission, reproduction is permissible only if reproduction is without alteration/omission.
- Though TOSHIBA works continually to improve Product's quality and reliability, Product can malfunction or fail. Customers are responsible for complying with safety standards and for providing adequate designs and safeguards for their hardware, software and systems which minimize risk and avoid situations in which a malfunction or failure of Product could cause loss of human life, bodily injury or damage to property, including data loss or corruption. Before customers use the Product, create designs including the Product, or incorporate the Product into their own applications, customers must also refer to and comply with (a) the latest versions of all relevant TOSHIBA information, including without limitation, this document, the specifications, the data sheets and application notes for Product and the precautions and conditions set forth in the "TOSHIBA Semiconductor Reliability Handbook" and (b) the instructions for the application with which the Product will be used with or for. Customers are solely responsible for all aspects of their own product design or applications, including but not limited to (a) determining the appropriateness of the use of this Product in such design or applications; (b) evaluating and determining the applicability of any information contained in this document, or in charts, diagrams, programs, algorithms, sample application circuits, or any other referenced documents; and (c) validating all operating parameters for such designs and applications. **TOSHIBA ASSUMES NO LIABILITY FOR CUSTOMERS' PRODUCT DESIGN OR APPLICATIONS.**
- Product is intended for use in general electronics applications (e.g., computers, personal equipment, office equipment, measuring equipment, industrial robots and home electronics appliances) or for specific applications as expressly stated in this document. Product is neither intended nor warranted for use in equipment or systems that require extraordinarily high levels of quality and/or reliability and/or a malfunction or failure of which may cause loss of human life, bodily injury, serious property damage or serious public impact ("Unintended Use"). Unintended Use includes, without limitation, equipment used in nuclear facilities, equipment used in the aerospace industry, medical equipment, equipment used for automobiles, trains, ships and other transportation, traffic signaling equipment, equipment used to control combustions or explosions, safety devices, elevators and escalators, devices related to electric power, and equipment used in finance-related fields. Do not use Product for Unintended Use unless specifically permitted in this document.
- Do not disassemble, analyze, reverse-engineer, alter, modify, translate or copy Product, whether in whole or in part.
- Product shall not be used for or incorporated into any products or systems whose manufacture, use, or sale is prohibited under any applicable laws or regulations.
- The information contained herein is presented only as guidance for Product use. No responsibility is assumed by TOSHIBA for any infringement of patents or any other intellectual property rights of third parties that may result from the use of Product. No license to any intellectual property right is granted by this document, whether express or implied, by estoppel or otherwise.
- **ABSENT A WRITTEN SIGNED AGREEMENT, EXCEPT AS PROVIDED IN THE RELEVANT TERMS AND CONDITIONS OF SALE FOR PRODUCT, AND TO THE MAXIMUM EXTENT ALLOWABLE BY LAW, TOSHIBA (1) ASSUMES NO LIABILITY WHATSOEVER, INCLUDING WITHOUT LIMITATION, INDIRECT, CONSEQUENTIAL, SPECIAL, OR INCIDENTAL DAMAGES OR LOSS, INCLUDING WITHOUT LIMITATION, LOSS OF PROFITS, LOSS OF OPPORTUNITIES, BUSINESS INTERRUPTION AND LOSS OF DATA, AND (2) DISCLAIMS ANY AND ALL EXPRESS OR IMPLIED WARRANTIES AND CONDITIONS RELATED TO SALE, USE OF PRODUCT, OR INFORMATION, INCLUDING WARRANTIES OR CONDITIONS OF MERCHANTABILITY, FITNESS FOR A PARTICULAR PURPOSE, ACCURACY OF INFORMATION, OR NONINFRINGEMENT.**
- Do not use or otherwise make available Product or related software or technology for any military purposes, including without limitation, for the design, development, use, stockpiling or manufacturing of nuclear, chemical, or biological weapons or missile technology products (mass destruction weapons). Product and related software and technology may be controlled under the Japanese Foreign Exchange and Foreign Trade Law and the U.S. Export Administration Regulations. Export and re-export of Product or related software or technology are strictly prohibited except in compliance with all applicable export laws and regulations.
- Please contact your TOSHIBA sales representative for details as to environmental matters such as the RoHS compatibility of Product. Please use Product in compliance with all applicable laws and regulations that regulate the inclusion or use of controlled substances, including without limitation, the EU RoHS Directive. TOSHIBA assumes no liability for damages or losses occurring as a result of noncompliance with applicable laws and regulations.

Mouser Electronics

Authorized Distributor

Click to View Pricing, Inventory, Delivery & Lifecycle Information:

Toshiba:

[ULN2803AFWG\(C,ELHA](#)