



! Partly to Be Discontinued:
10A type (Made in Thailand)
Last time buy: September 30, 2016

1a/1c 5A/10A small power relays

JQ RELAYS



RoHS compliant

FEATURES

- High electrical noise immunity
- High switching capacity in a compact package
- High sensitivity: 200 mW (1a), 400 mW (1c)
- High surge voltage: 8,000 V between contacts and coil
- UL, CSA, VDE, SEMKO approved and TÜV available
- Class B coil insulation type also available.

TYPICAL APPLICATIONS

- Air conditioners
- Refrigerators
- Microwave ovens
- Heaters

ORDERING INFORMATION

JQ - - - **F**

Contact arrangement
1a: 1 Form A
1 : 1 Form C

Contact capacity
Nil: Standard (5A)
P: High capacity (10A)

Coil insulation class
Nil: Class E coil insulation
B: Class B coil insulation (UL)

Nominal coil voltage (DC)
5V, 6V, 9V, 12V, 18V, 24V, 48V*

Contact material
F: AgSnO₂ type

Certified by UL, CSA, VDE and SEMKO
Note: *Available only for 1 Form C type

TYPES

1) Standard type

Nominal coil voltage	Standard type		High capacity type	
	1 Form A	1 Form C	1 Form A	1 Form C
	Part No.	Part No.	Part No.	Part No.
5V DC	JQ1a-5V-F	JQ1-5V-F	JQ1aP-5V-F	JQ1P-5V-F
6V DC	JQ1a-6V-F	JQ1-6V-F	JQ1aP-6V-F	JQ1P-6V-F
9V DC	JQ1a-9V-F	JQ1-9V-F	JQ1aP-9V-F	JQ1P-9V-F
12V DC	JQ1a-12V-F	JQ1-12V-F	JQ1aP-12V-F	JQ1P-12V-F
18V DC	JQ1a-18V-F	JQ1-18V-F	JQ1aP-18V-F	JQ1P-18V-F
24V DC	JQ1a-24V-F	JQ1-24V-F	JQ1aP-24V-F	JQ1P-24V-F
48V DC	-	JQ1-48V-F	-	JQ1P-48V-F

Standard packing: Carton 100 pcs., Case 500 pcs.

RATING

1. Coil data

Contact arrangement	Nominal coil voltage	Pick-up voltage (at 20°C 68°F)	Drop-out voltage (at 20°C 68°F)	Nominal operating current [$\pm 10\%$] (at 20°C 68°F)	Coil resistance [$\pm 10\%$] (at 20°C 68°F)	Nominal operating power (at 20°C 68°F)	Max. applied voltage
1 Form A	5V DC	Standard type: 75%V or less of nominal voltage (Initial)	5%V or more of nominal voltage (Initial)	40.0mA	125 Ω	200mW	180% of nominal voltage (at 20°C 68°F)
	6V DC			33.3mA	180 Ω		
	9V DC			22.2mA	405 Ω		
	12V DC	High capacity type: 80%V or less of nominal voltage (Initial)		16.7mA	720 Ω		130% of nominal voltage (at 70°C 158°F) [When using relays at 85°C 185°F, see Notes*4]
	18V DC			11.1mA	1,620 Ω		
	24V DC			8.3mA	2,880 Ω		
1 Form C	5V DC	Standard type: 75%V or less of nominal voltage (Initial)	5%V or more of nominal voltage (Initial)	80 mA	62.5 Ω	400mW	150% of nominal voltage (at 20°C 68°F)
	6V DC			66.7mA	90 Ω		
	9V DC			44.4mA	202.5 Ω		
	12V DC	High capacity type: 80%V or less of nominal voltage (Initial)		33.3mA	360 Ω		110% of nominal voltage (at 70°C 158°F) [When using relays at 85°C 185°F, see Notes*4]
	18V DC			22.2mA	810 Ω		
	24V DC			16.7mA	1,440 Ω		
	48V DC			8.3mA	5,760 Ω		

2. Specifications

Characteristics	Item	Specifications				
		Standard type		High capacity type		
Contact	Arrangement	1 Form A	1 Form C	1 Form A	1 Form C	
	Contact resistance (Initial)	Max. 100m Ω (By voltage drop 6 V DC 1 A)				
	Contact material	AgSnO ₂ type				
Rating	Nominal switching capacity (resistive load)	5 A 125 V AC, 2 A 250 V AC, 5 A 30 V DC	N.O. side: 5 A 125 V AC, 2 A 250 V AC, 3 A 30 V AC N.C. side: 2 A 125 V AC, 1 A 250 V AC, 1 A 30 V DC	10 A 125 V AC, 5 A 250 V AC, 5 A 30 V DC	N.O. side: 10 A 125 V AC, 5 A 250 V AC, 5 A 30 V AC N.C. side: 3 A 125 V AC, 2 A 250 V AC, 1 A 30 V DC	
	Max. switching power (resistive load)	625 VA, 150 W	N.O. side: 625 VA, 90 W N.C. side: 250 VA, 30 W	1,250 V AC, 150 W	N.O. side: 1,250 VA, 150 W N.C. side: 500 V AC, 30 W	
	Max. switching voltage	250 V AC, 110 V DC (0.3A)				
	Max. switching current	N.O.: 5 A, N.C.: 2 A		N.O.: 10 A, N.C.: 3 A		
	Nominal operating power	200 mW	400 mW	200 mW	400 mW	
	Min. switching capacity (reference value)*1	100 mA, 5 V DC				
	Insulation resistance (Initial)	Min. 1,000 M Ω (at 500 V DC) Measurement at same location as "Breakdown voltage" section.				
Electrical characteristics	Breakdown voltage (Initial)	Between open contacts	1,000 Vrms for 1 min.	750 Vrms for 1 min.	1,000 Vrms for 1 min.	750 Vrms for 1 min.
		Between contact and coil	4,000 Vrms for 1 min. (Detection current: 10 mA)			
	Temperature rise (coil)	Max. 45°C 113°F (By resistive method, nominal coil voltage applied to the coil; contact carrying current: 5A, at 70°C 158°F)		Max. 45°C 113°F (By resistive method, nominal coil voltage applied to the coil; contact carrying current: 10A, at 70°C 158°F)		
	Surge breakdown voltage*2 (Between contact and coil) (Initial)	8,000 V				
	Operate time (at nominal voltage) (at 20°C 68°F) (Initial)	Max. 20 ms (excluding contact bounce time.)				
	Release time (at nominal voltage) (at 20°C 68°F) (Initial)	Max. 10 ms (excluding contact bounce time) (Without diode)				
	Mechanical characteristics	Shock resistance	Functional	294 m/s ² (Half-wave pulse of sine wave: 11 ms; detection time: 10 μ s.)		
Destructive			980 m/s ² (Half-wave pulse of sine wave: 6 ms.)			
Vibration resistance		Functional	10 to 55 Hz at double amplitude of 1.6 mm (Detection time: 10 μ s.)			
		Destructive	10 to 55 Hz at double amplitude of 2.0 mm			
Expected life	Mechanical (at 180 times/min.)	Min. 10 ⁷				
Conditions	Conditions for operation, transport and storage*3	Ambient temperature: -40°C to +70°C -40°F to +158°F (class E insulation), -40°C to +85°C -40°F to +185°F*4 (class B insulation) Humidity: 5 to 85% R.H. (Not freezing and condensing at low temperature)				
	Max. operating speed	20 times/min. (at nominal switching capacity)				
Unit weight		Approx. 7 g .25 oz				

* Specifications will vary with foreign standards certification ratings.

Notes: *1. This value can change due to the switching frequency, environmental conditions, and desired reliability level, therefore it is recommended to check this with the actual load.

*2. Wave is standard shock voltage of $\pm 1.2 \times 50 \mu$ s according to JEC-212-1981

*3. The upper limit of the ambient temperature is the maximum temperature that can satisfy the coil temperature rise value. Refer to Usage, transport and storage conditions in NOTES.

*4. When using relays in a high ambient temperature, consider the pick-up voltage rise due to the high temperature (a rise of approx. 0.4% V for each 1°C 33.8°F with 20°C 68°F as a reference) and use a coil impressed voltage that is within the maximum applied voltage range.

3. Expected electrical life

Type		Switching capacity		No. of operations
Standard type	1 Form A	5 A 125 V AC		5×10 ⁴
		3 A 125 V AC		2×10 ⁵
	1 Form C	2 A 250 V AC		2×10 ⁵
		5 A 30 V DC		10 ⁵
High capacity type	1 Form A	5 A 125 V AC		5×10 ⁴
		3 A 125 V AC		2×10 ⁵
	1 Form C	2 A 250 V AC		2×10 ⁵
		5 A 30 V DC		10 ⁵
High capacity type	1 Form A	10 A 125 V AC		5×10 ⁴
		5 A 250 V AC		5×10 ⁴
	1 Form C	5 A 30 V DC		10 ⁵
		3 A 125 V AC		2×10 ⁵
		2 A 250 V AC		2×10 ⁵
		1 A 30 V DC		10 ⁵

REFERENCE DATA

1.-(1) Max. switching capacity (1 Form A type)

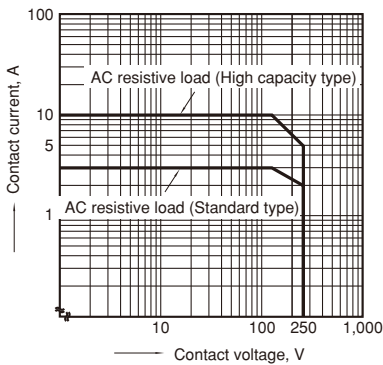

1.-(2) Max. switching capacity (1 Form C type)

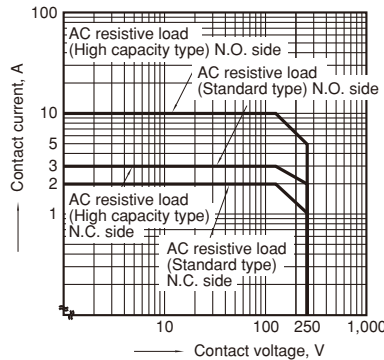

Standard type

2. Life curve

Ambient temperature: room temperature

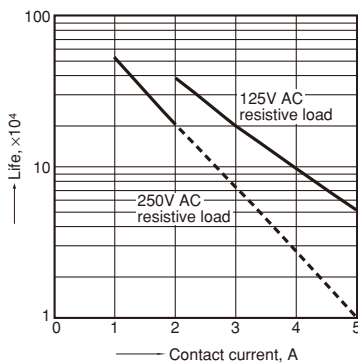

3.-(1) Operate & release time (1 Form A type)

Tested sample: JQ1a-12V-F, 25 pcs.

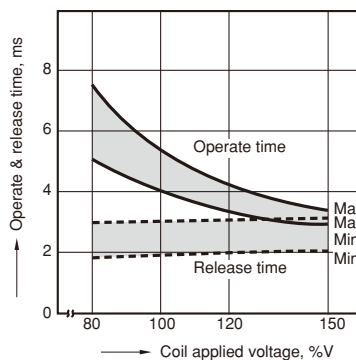

3.-(2) Operate & release time (1 Form C type)

Tested sample: JQ1-24V-F, 25 pcs.

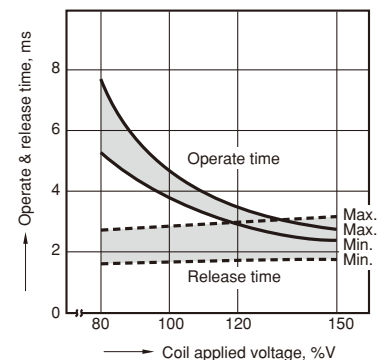

4.-(1) Coil temperature rise (1 Form A type)

Contact carrying current: 3 A, 5 A
Measured portion: Inside the coil

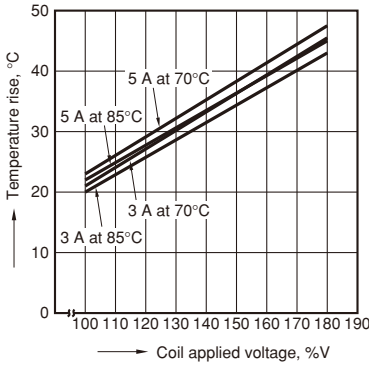

4.-(2) Coil temperature rise (1 Form C type)

Contact carrying current: 3 A, 5 A
Measured portion: Inside the coil

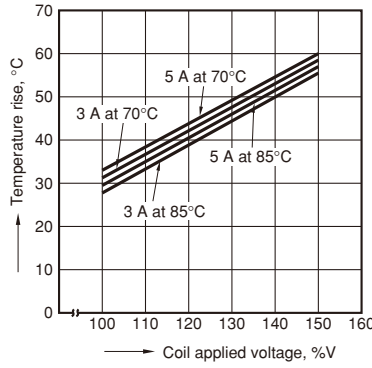

5.-(1) Ambient temperature characteristics (1 Form A type)

Tested sample: JQ1a-24V-F
Contact carrying current: 3 A, 5 A

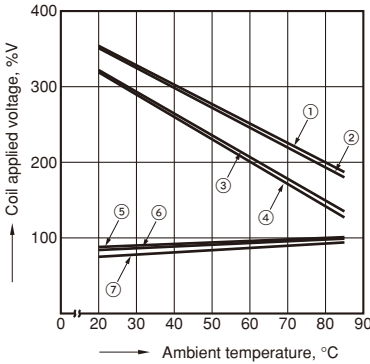

5.-(2) Ambient temperature characteristics (1 Form C type)

Tested sample: JQ1-24V-F
Contact carrying current: 3 A, 5 A

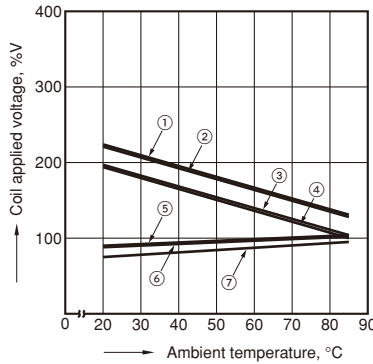

- ① Allowable ambient temperature against % coil voltage (max. inside the coil temperature set as 130°C 266°F) (Carrying current: 3 A)
- ② Allowable ambient temperature against % coil voltage (max. inside the coil temperature set as 130°C 266°F) (Carrying current: 5 A)
- ③ Allowable ambient temperature against % coil voltage (max. inside the coil temperature set as 115°C 239°F) (Carrying current: 3 A)
- ④ Allowable ambient temperature against % coil voltage (max. inside the coil temperature set as 115°C 239°F) (Carrying current: 5 A)
- ⑤ Pick-up voltage with a hot-start condition of 100%V on the coil (Carrying current: 5 A)
- ⑥ Pick-up voltage with a hot-start condition of 100%V on the coil (Carrying current: 3 A)
- ⑦ Pick-up voltage

High capacity type

1. Life curve

Ambient temperature: room temperature

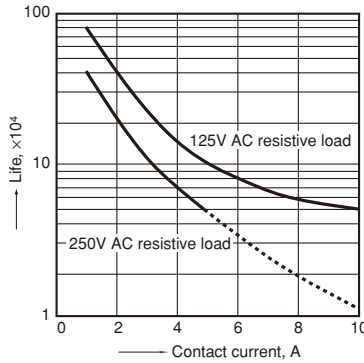

2.-(1) Operate & release time (1 Form A type)

Tested sample: JQ1aP-12V-F, 25 pcs.

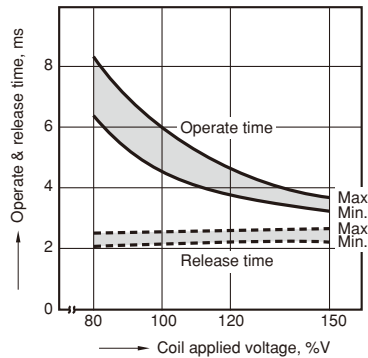

2.-(2) Operate & release time (1 Form C type)

Tested sample: JQ1P-12V-F, 25 pcs.

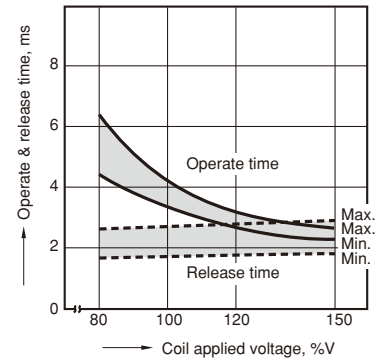

3.-(1) Coil temperature rise (1 Form A type)

Contact carrying current: 5 A, 10 A
Measured portion: Inside the coil

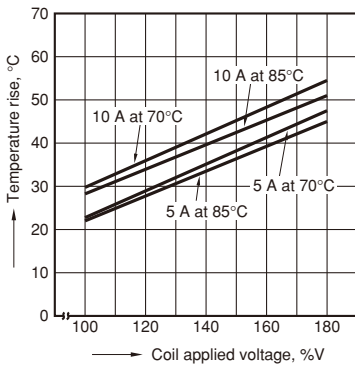

3.-(2) Coil temperature rise (1 Form C type)

Contact carrying current: 5 A, 10 A
Measured portion: Inside the coil

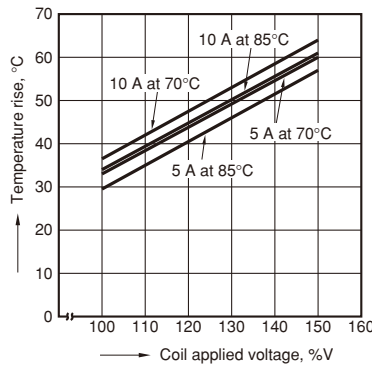

4.-(1) Ambient temperature characteristics
(1 Form A type)
Tested sample: JQ1aP-24V-F
Contact carrying current: 5 A, 10 A

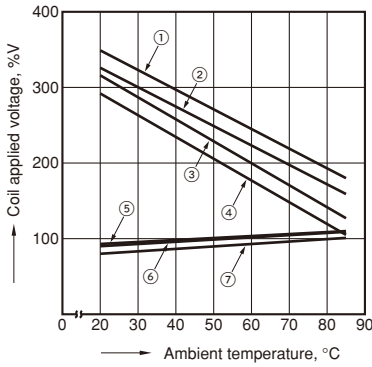

4.-(2) Ambient temperature characteristics
(1 Form C type)
Tested sample: JQ1P-24V-F
Contact carrying current: 5 A, 10 A

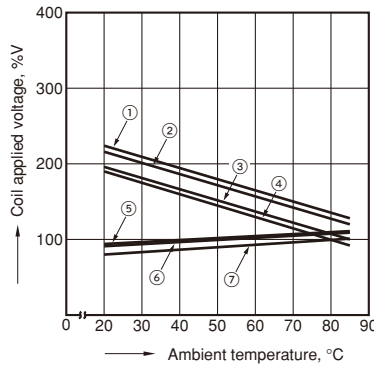

- ① Allowable ambient temperature against % coil voltage (max. inside the coil temperature set as 130°C 266°F) (Carrying current: 5 A)
- ② Allowable ambient temperature against % coil voltage (max. inside the coil temperature set as 130°C 266°F) (Carrying current: 10 A)
- ③ Allowable ambient temperature against % coil voltage (max. inside the coil temperature set as 115°C 239°F) (Carrying current: 5 A)
- ④ Allowable ambient temperature against % coil voltage (max. inside the coil temperature set as 115°C 239°F) (Carrying current: 10 A)
- ⑤ Pick-up voltage with a hot-start condition of 100%V on the coil (Carrying current: 10 A)
- ⑥ Pick-up voltage with a hot-start condition of 100%V on the coil (Carrying current: 5 A)
- ⑦ Pick-up voltage

DIMENSIONS (mm inch)

The CAD data of the products with a **CAD Data** mark can be downloaded from: <http://industrial.panasonic.com/ac/e/>

CAD Data

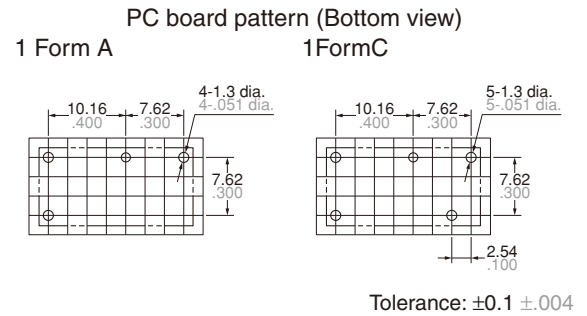
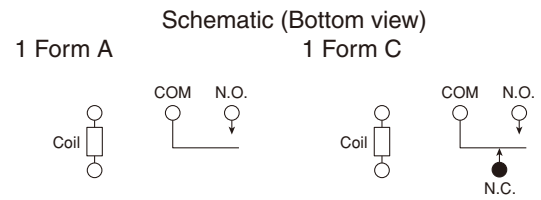
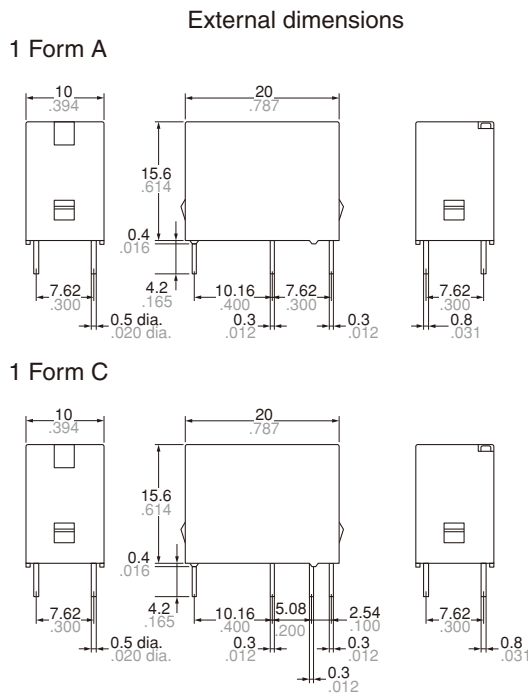

Dimension:	General tolerance
Less than 1mm .039inch:	$\pm 0.2 \pm 0.008$
Min. 1mm .039inch less than 5mm .197 inch:	$\pm 0.3 \pm 0.012$
Min. 5mm .197 inch:	$\pm 0.4 \pm 0.016$

SAFETY STANDARDS

Item	UL/C-UL (Recognized)		CSA (Certified)		VDE (Certified)		TÜV (Certified)		SEMKO (Certified)	
	File No.	Contact rating	File No.	Contact rating	File No.	Contact rating	File No.	Rating	File No.	Contact rating
Standard type (5A) 1 Form A	E43028	5A 125V AC 5A 277V AC 5A 30V DC 0.3A 110V DC 1/10HP 125V AC 1/6HP 277V AC	LR26550	5A 125V AC 5A 277V AC 5A 30V DC 0.3A 110V DC 1/10HP 125V AC 1/6HP 277V AC	40011435	5A 250V AC (cosφ=0.4)	B 11 04 13461 296	5A 250V AC (cosφ=0.4) 5A 30V DC (0ms)	817138	3(2)A 125V AC 2(1)A 250V AC 5A 30V DC
Standard type (5A) 1 Form C	E43028	5A 125V AC 5A 277V AC 5A 30V DC 0.3A 110V DC 1/10HP 125V AC 1/6HP 277V AC	LR26550	5A 125V AC 5A 277V AC 5A 30V DC 0.3A 110V DC 1/10HP 125V AC 1/6HP 277V AC	40011435	5A 250V AC (cosφ=0.4) (N.O.) 3A 250V AC (cosφ=0.4) (N.C.)	B 11 04 13461 296	5A 250V AC (cosφ=0.4) 5A 30V DC (0ms)	817138	3(2)A 125V AC 2(1)A 250V AC 5A 30V DC
High capacity type (10A) 1 Form A	E43028	10A 125V AC 8A 277V AC 5A 30V DC 0.3A 110V DC 1/6HP 125V AC 1/6HP 277V AC	LR26550	10A 125V AC 8A 277V AC 5A 30V DC 0.3A 110V DC 1/6HP 125V AC 1/6HP 277V AC	40011435	10A 250V AC (cosφ=0.4)	B 11 04 13461 296	10A 250V AC (cosφ=0.4) 5A 30V DC (0ms)	817138	5(3)A 250V AC 5A 30V DC
High capacity type (10A) 1 Form C	E43028	10A 125V AC 8A 277V AC 5A 30V DC 0.3A 110V DC 1/6HP 125V AC 1/6HP 277V AC	LR26550	10A 125V AC 8A 277V AC 5A 30V DC 0.3A 110V DC 1/6HP 125V AC 1/6HP 277V AC	40011435	(N.O.) 10A 250V AC (cosφ=0.4) (N.C.) 3A 250V AC (cosφ=0.4)	B 11 04 13461 296	10A 250V AC (cosφ=0.4) 5A 30V DC (0ms)	817138	5(3)A 250V AC 5A 30V DC

NOTES

Note about relay installation orientation

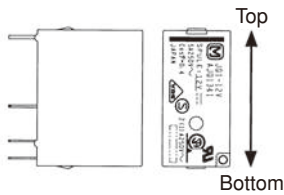

When installing with the relay terminals parallel to the ground, the contact terminals at the bottom and the coil terminals at the top, component friction will occur after numerous switching actions or due to vibration in the non-excitation state. Since this may cause the relay to stop functioning when the pick-up voltage increases even if the nominal voltage is applied, please do not install using this orientation.

For Cautions for Use.